

# OmniStream™ Single-Channel / Dual-Channel Networked AV Encoder



AT-OMNI-111 AT-OMNI-112

Atlona Manuals  
**Networked AV**

## Version Information

---

Version	Release Date	Notes
1	04/17	Initial release
2	06/17	New enclosure, documentation updates: AMS interface; front-panel buttons, decoder set tab

## Welcome to Atlona!

---

Thank you for purchasing this Atlona product. We hope you enjoy it and will take a extra few moments to register your new purchase.

Registration only takes a few minutes and protects this product against theft or loss. In addition, you will receive notifications of product updates and firmware. Atlona product registration is voluntary and failure to register will not affect the product warranty.

To register your product, go to <http://www.atlona.com/registration>

## Sales, Marketing, and Customer Support

---

### Main Office

Atlona Incorporated  
70 Daggett Drive  
San Jose, CA 95134  
United States

Office: +1.877.536.3976 (US Toll-free)  
Office: +1.408.962.0515 (US/International)

Sales and Customer Service Hours  
Monday - Friday: 6:00 a.m. - 4:30 p.m. (PST)

<http://www.atlona.com/>

### International Headquarters

Atlona International AG  
Ringstrasse 15a  
8600 Dübendorf  
Switzerland

Office: +41 43 508 4321

Sales and Customer Service Hours  
Monday - Friday: 09:00 - 17:00 (UTC +1)

## Operating Notes

---

- The Atlona Management System (AMS) is a free downloadable application from Atlona that provides network configuration assistance for this product. This application is available only for the Windows® Operating System and can be downloaded from the Atlona web site.



**IMPORTANT:** Visit <http://www.atlona.com/product/AT-OMNI-111> and <http://www.atlona.com/product/AT-OMNI-112> for the latest firmware updates and User Manual.

# Atlona, Inc. (“Atlona”) Limited Product Warranty

---

## Coverage

Atlona warrants its products will substantially perform to their published specifications and will be free from defects in materials and workmanship under normal use, conditions and service.

Under its Limited Product Warranty, Atlona, at its sole discretion, will either:

- repair or facilitate the repair of defective products within a reasonable period of time, restore products to their proper operating condition and return defective products free of any charge for necessary parts, labor and shipping.

OR

- replace and return, free of charge, any defective products with direct replacement or with similar products deemed by Atlona to perform substantially the same function as the original products.

OR

- refund the pro-rated value based on the remaining term of the warranty period, not to exceed MSRP, in cases where products are beyond repair and/or no direct or substantially similar replacement products exist.

Repair, replacement or refund of Atlona products is the purchaser’s exclusive remedy and Atlona liability does not extend to any other damages, incidental, consequential or otherwise.

This Limited Product Warranty extends to the original end-user purchaser of Atlona products and is non-transferrable to any subsequent purchaser(s) or owner(s) of these products.

## Coverage Periods

Atlona Limited Product Warranty Period begins on the date of purchase by the end-purchaser. The date contained on the end-purchaser’s sales or delivery receipt is the proof purchase date.

### Limited Product Warranty Terms – New Products

- 10 years from proof of purchase date for hardware/electronics products purchased on or after June 1, 2013.
- 3 years from proof of purchase date for hardware/electronics products purchased before June 1, 2013.
- Lifetime Limited Product Warranty for all cable products.

### Limited Product Warranty Terms – Refurbished (B-Stock) Products

- 3 years from proof of purchase date for all Refurbished (B-Stock) hardware and electronic products purchased on or after June 1, 2013.

## Remedy

Atlona recommends that end-purchasers contact their authorized Atlona dealer or reseller from whom they purchased their products. Atlona can also be contacted directly. Visit [www.atlona.com](http://www.atlona.com) for Atlona’s contact information and hours of operation. Atlona requires that a dated sales or delivery receipt from an authorized dealer, reseller or end-purchaser is provided before Atlona extends its warranty services. Additionally, a return merchandise authorization (RMA) and/or case number, is required to be obtained from Atlona in advance of returns.

Atlona requires that products returned are properly packed, preferably in the original carton, for shipping. Cartons not bearing a return authorization or case number will be refused. Atlona, at its sole discretion, reserves the right to reject any products received without advanced authorization. Authorizations can be requested by calling 1-877-536-3976 (US toll free) or 1-408- 962-0515 (US/international) or via Atlona’s website at [www.atlona.com](http://www.atlona.com).

## Exclusions

This Limited Product Warranty excludes:

- Damage, deterioration or malfunction caused by any alteration, modification, improper use, neglect, improper packaging or shipping (such claims must be presented to the carrier), lightning, power surges, or other acts of nature.

## Atlona, Inc. (“Atlona”) Limited Product Warranty

---

- Damage, deterioration or malfunction resulting from the installation or removal of this product from any installation, any unauthorized tampering with this product, any repairs attempted by anyone unauthorized by Atlona to make such repairs, or any other cause which does not relate directly to a defect in materials and/or workmanship of this product.
- Equipment enclosures, cables, power supplies, batteries, LCD displays, and any accessories used in conjunction with the product(s).
- Products purchased from unauthorized distributors, dealers, resellers, auction websites and similar unauthorized channels of distribution.

### Disclaimers

This Limited Product Warranty does not imply that the electronic components contained within Atlona’s products will not become obsolete nor does it imply Atlona products or their electronic components will remain compatible with any other current product, technology or any future products or technologies in which Atlona’s products may be used in conjunction with. Atlona, at its sole discretion, reserves the right not to extend its warranty offering in instances arising outside its normal course of business including, but not limited to, damage inflicted to its products from acts of god.

### Limitation on Liability

The maximum liability of Atlona under this limited product warranty shall not exceed the original Atlona MSRP for its products. To the maximum extent permitted by law, Atlona is not responsible for the direct, special, incidental or consequential damages resulting from any breach of warranty or condition, or under any other legal theory. Some countries, districts or states do not allow the exclusion or limitation of relief, special, incidental, consequential or indirect damages, or the limitation of liability to specified amounts, so the above limitations or exclusions may not apply to you.

### Exclusive Remedy

To the maximum extent permitted by law, this limited product warranty and the remedies set forth above are exclusive and in lieu of all other warranties, remedies and conditions, whether oral or written, express or implied. To the maximum extent permitted by law, Atlona specifically disclaims all implied warranties, including, without limitation, warranties of merchantability and fitness for a particular purpose. If Atlona cannot lawfully disclaim or exclude implied warranties under applicable law, then all implied warranties covering its products including warranties of merchantability and fitness for a particular purpose, shall provide to its products under applicable law. If any product to which this limited warranty applies is a “Consumer Product” under the Magnuson-Moss Warranty Act (15 U.S.C.A. §2301, ET SEQ.) or other applicable law, the foregoing disclaimer of implied warranties shall not apply, and all implied warranties on its products, including warranties of merchantability and fitness for the particular purpose, shall apply as provided under applicable law.

### Other Conditions

Atlona’s Limited Product Warranty offering gives legal rights, and other rights may apply and vary from country to country or state to state. This limited warranty is void if (i) the label bearing the serial number of products have been removed or defaced, (ii) products are not purchased from an authorized Atlona dealer or reseller. A comprehensive list of Atlona’s authorized distributors, dealers and resellers can be found at [www.atlona.com](http://www.atlona.com).

## Important Safety Information



CAUTION: TO REDUCT THE RISK OF ELECTRIC SHOCK DO NOT OPEN ENCLOSURE OR EXPOSE TO RAIN OR MOISTURE. NO USER-SERVICEABLE PARTS INSIDE REFER SERVICING TO QUALIFIED SERVICE PERSONNEL.



The exclamation point within an equilateral triangle is intended to alert the user to the presence of important operating and maintenance instructions in the literature accompanying the product.



The information bubble is intended to alert the user to helpful or optional operational instructions in the literature accompanying the product.

1. Read these instructions.
2. Keep these instructions.
3. Heed all warnings.
4. Follow all instructions.
5. Do not use this product near water.
6. Clean only with a dry cloth.
7. Do not block any ventilation openings. Install in accordance with the manufacturer's instructions.
8. Do not install or place this product near any heat sources such as radiators, heat registers, stoves, or other apparatus (including amplifiers) that produce heat.
9. Do not defeat the safety purpose of a polarized or grounding-type plug. A polarized plug has two blades with one wider than the other. A grounding type plug has two blades and a third grounding prong. The wide blade or the third prong are provided for your safety. If the provided plug does not fit into your outlet, consult an electrician for replacement of the obsolete outlet.
10. Protect the power cord from being walked on or pinched particularly at plugs, convenience receptacles, and the point where they exit from the product.
11. Only use attachments/accessories specified by Atlona.
12. To reduce the risk of electric shock and/or damage to this product, never handle or touch this unit or power cord if your hands are wet or damp. Do not expose this product to rain or moisture.
13. Unplug this product during lightning storms or when unused for long periods of time.
14. Refer all servicing to qualified service personnel. Servicing is required when the product has been damaged in any way, such as power-supply cord or plug is damaged, liquid has been spilled or objects have fallen into the product, the product has been exposed to rain or moisture, does not operate normally, or has been dropped.



## FCC Statement

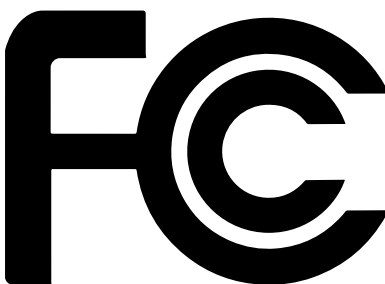

FCC Compliance and Advisory Statement: This hardware device complies with Part 15 of the FCC rules. Operation is subject to the following two conditions: 1) this device may not cause harmful interference, and 2) this device must accept any interference received including interference that may cause undesired operation. This equipment has been tested and found to comply with the limits for a Class A digital device, pursuant to Part 15 of the FCC Rules. These limits are designed to provide reasonable protection against harmful interference in a commercial installation.

This equipment generates, uses, and can radiate radio frequency energy and, if not installed or used in accordance with the instructions, may cause harmful interference to radio communications. However there is no guarantee that interference will not occur in a particular installation. If this equipment does cause harmful interference to radio or television reception, which can be determined by turning the equipment off and on, the user is encouraged to try to correct the interference by one or more of the following measures: 1) reorient or relocate the receiving antenna; 2) increase the separation between the equipment and the receiver; 3) connect the equipment to an outlet on a circuit different from that to which the receiver is connected; 4) consult the dealer or an experienced radio/TV technician for help. Any changes or modifications not expressly approved by the party responsible for compliance could void the user's authority to operate the equipment. Where shielded interface cables have been provided with the product or specified additional components or accessories elsewhere defined to be used with the installation of the product, they must be used in order to ensure compliance with FCC regulations.

# Table of Contents

---

<b>Introduction</b>	<b>9</b>
<b>Features</b>	<b>9</b>
<b>Package Contents</b>	<b>9</b>
<b>Panel Description</b>	<b>10</b>
AT-OMNI-111	10
AT-OMNI-112	11
<b>Installation</b>	<b>12</b>
RS-232	12
Connection Instructions	12
Connection Diagram	13
<b>Configuration</b>	<b>14</b>
Discovery using AMS	14
Configuring a Static IP Address	16
Manual Setup	18
Checking the Input	18
Input Selection	19
Session Configuration	21
<b>Front Panel Controls</b>	<b>25</b>
Rebooting OmniStream	25
Selecting the Input	25
Powering the Display	25
Adjusting Volume	26
Single-output Mode	26
Dual-output Mode	26
ID Button	27
Broadcast Messaging	27
Reset to Factory-Default Settings.	27
<b>The Virtual Matrix</b>	<b>28</b>
Accessing the Virtual Matrix	28
Layout	28
Physical Interfaces and Cross Connections	31
Creating Cross Connections	32
Data-Specific Cross Connections	34
Removing Cross Connections	35
Scrambling	36
Configuring Redundant Streams	37
<b>The AMS Interface</b>	<b>38</b>
System Information tab	38
Input tab	40
Encoding tab	43
Serial tab	44
Session tab	46
Logo tab	50
Alarms tab	51
Platform	51
Video Interface	51
Audio I/F	52
IP Protocol	52
Network tab	53
Users tab	54
License tab	55
Demo tab	56

## Table of Contents

---

<b>Appendix</b>	<b>57</b>
FEC Details	57
Matrix Size, Overhead, and Latency	57
FEC and Video Bitrate	57
FEC, Latency, and Lip Sync	58
Mounting Instructions	59
Rack Tray for OmniStream	60
Specifications	61



## Introduction

---

The Atlona OmniStream™ 111 (AT-OMNI-111) is a networked AV encoder for one HDMI source up to 4K/UHD, plus embedded audio and RS-232 control. The Atlona OmniStream™ 112 (AT-OMNI-112) adds a second channel of encoding for two HDMI sources up to 4K/UHD and RS-232 control and can deliver duplicate AV streams to two networks for full system redundancy in mission-critical applications. OmniStream features SMPTE VC-2 compression for critical-quality video applications, with extremely low, sub-frame latency from encode to decode. It also includes selectable AES-128 encryption and SMPTE 2022-5 Forward Error Correction (FEC) for robust AV distribution spanning multiple networks. This encoder is housed in a half-rack width enclosure. Both OmniStream encoders are housed in compact enclosures that easily fit into a half RU space. They can be powered over the network through Power over Ethernet (PoE) or optionally from local AC power.

OmniStream was engineered from the ground up at Atlona to deliver the performance and dependability of traditional AV distribution, with the virtually unlimited scalability and cost efficiency of integrating over data networks. It addresses the many challenges AV and IT integrators encounter with implementing networked AV systems, while delivering immediate and long-term ROI to end users in enterprises and other organizations

## Features

---

### OmniStream Single-Channel Encoder

- Single-channel AV encoder for HDMI up to 4K/UHD
- SMPTE VC-2 compression
- RS-232 control
- Selectable AES-128 encryption
- SMPTE 2022-5 FEC
- Powered using PoE or optional external 48V DC power supply

### OmniStream Dual-Channel Encoder

- Dual-channel AV encoder for HDMI up to 4K/UHD
- Secondary channel provides redundancy for mission-critical applications
- SMPTE VC-2 compression
- RS-232 control
- Selectable AES-128 encryption
- SMPTE 2022-5 (FEC)
- Powered using PoE or optional external 48V DC power supply

## Package Contents

---

### OmniStream Single-Channel Encoder

- 1 x AT-OMNI-111
- 1 x Phoenix terminal block, 6-pin (push spring)
- 1 x Wall/table mounting brackets
- 4 x Rubber feet
- 1 x Installation Guide

### OmniStream Dual-Channel Encoder

- 1 x AT-OMNI-112
- 1 x Phoenix terminal block, 6-pin (push spring)
- 1 x Wall/table mounting brackets
- 4 x Rubber feet
- 1 x Installation Guide

# Panel Description

## AT-OMNI-111



Front

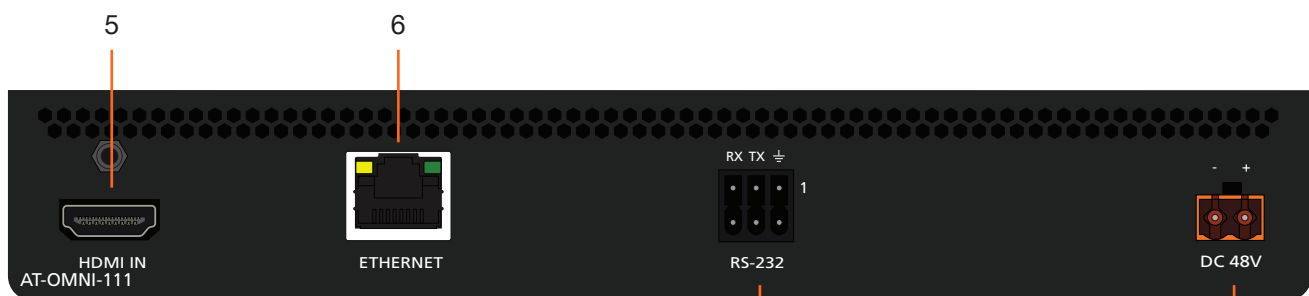

Rear

- |                                                                                                                                                                                                                                                                                                                                                                                                                                        |                                                                                                                                                                                                                                                                                                                                  |
|----------------------------------------------------------------------------------------------------------------------------------------------------------------------------------------------------------------------------------------------------------------------------------------------------------------------------------------------------------------------------------------------------------------------------------------|----------------------------------------------------------------------------------------------------------------------------------------------------------------------------------------------------------------------------------------------------------------------------------------------------------------------------------|
| <p><b>1 PWR</b><br/>This LED indicator glows bright green when the unit is powered.</p> <p><b>2 HDMI</b><br/>This LED indicator shows the input status.</p> <p><b>3 LINK</b><br/>This LED indicator shows the link status of the encoder.</p> <p><b>4 REBOOT</b><br/>Use a small, pointed object to press this recessed button and reboot the unit.</p> <p><b>5 HDMI</b><br/>Connect an HDMI cable from this port to an HD source.</p> | <p><b>6 ETHERNET</b><br/>Connect an Ethernet cable from this port to the Local Area Network (LAN).</p> <p><b>7 RS-232</b><br/>Use the included Phoenix terminal block to connect up to two RS-232 controllers or automation systems.</p> <p><b>8 DC 48V</b><br/>Connect the included 48V DC power supply to this receptacle.</p> |
|----------------------------------------------------------------------------------------------------------------------------------------------------------------------------------------------------------------------------------------------------------------------------------------------------------------------------------------------------------------------------------------------------------------------------------------|----------------------------------------------------------------------------------------------------------------------------------------------------------------------------------------------------------------------------------------------------------------------------------------------------------------------------------|

## AT-OMNI-112

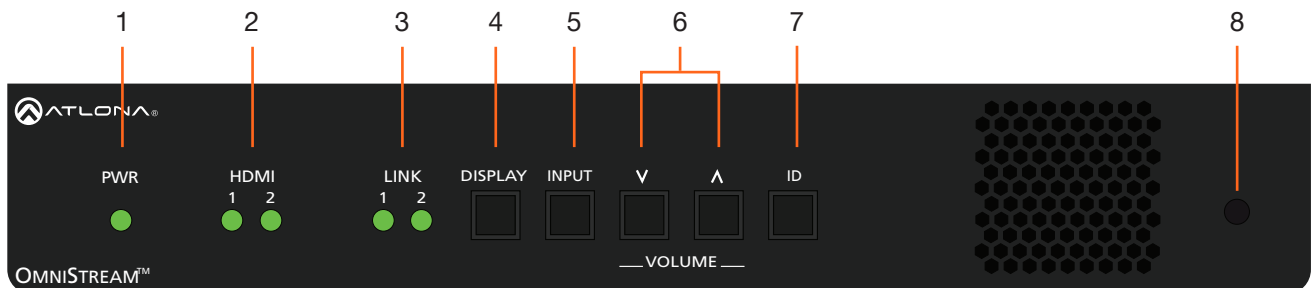

Front

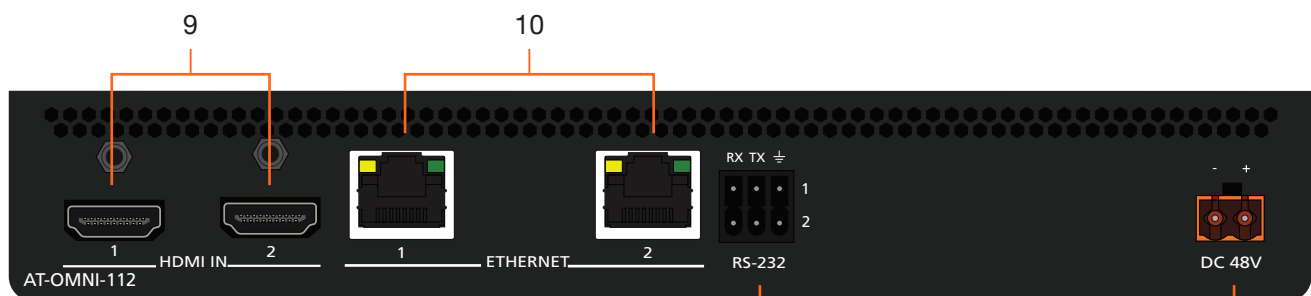

Rear

- |                                                                                                                                                                                                                                                                                                                                                                                                                                                                                                                                                                                                                                                                                                                                                                                                              |                                                                                                                                                                                                                                                                                                                                                                                                                                                                                                                                                                                                                                                                                                                                                                                                          |
|--------------------------------------------------------------------------------------------------------------------------------------------------------------------------------------------------------------------------------------------------------------------------------------------------------------------------------------------------------------------------------------------------------------------------------------------------------------------------------------------------------------------------------------------------------------------------------------------------------------------------------------------------------------------------------------------------------------------------------------------------------------------------------------------------------------|----------------------------------------------------------------------------------------------------------------------------------------------------------------------------------------------------------------------------------------------------------------------------------------------------------------------------------------------------------------------------------------------------------------------------------------------------------------------------------------------------------------------------------------------------------------------------------------------------------------------------------------------------------------------------------------------------------------------------------------------------------------------------------------------------------|
| <p><b>1 PWR</b><br/>This LED indicator glows bright green when the unit is powered.</p> <p><b>2 HDMI 1 / HDMI 2</b><br/>These LED indicators show the active input status.</p> <p><b>3 LINK 1 / LINK 2</b><br/>These LED indicators show the link status of the encoder.</p> <p><b>4 DISPLAY</b><br/>Press this button to toggle the power state of the desired display. Refer to <a href="#">Powering the Display (page 25)</a> for more information.</p> <p><b>5 INPUT</b><br/>Press this button to switch between HDMI 1 and HDMI 2 inputs. Refer to <a href="#">Selecting the Input (page 25)</a> for more information.</p> <p><b>6 VOLUME</b><br/>Press these buttons to adjust the output volume of the desired display. Refer to <a href="#">Adjusting Volume (page 26)</a> for more information.</p> | <p><b>7 ID</b><br/>Press this button to send out a broadcast message to any network devices that are listening. This button is also used to set the encoder to factory-default settings. Refer to <a href="#">ID Button (page 27)</a> for more information.</p> <p><b>8 REBOOT</b><br/>Press this button, using a small, pointed object to reboot the unit.</p> <p><b>9 HDMI IN 1 / HDMI IN 2</b><br/>Connect HDMI cables from these ports to an HD source.</p> <p><b>10 Eth 1 / Eth 2</b><br/>Connect Ethernet cables from these ports to the Local Area Network (LAN).</p> <p><b>11 RS-232</b><br/>Use the included Phoenix terminal block to connect up to two RS-232 controllers or automation systems.</p> <p><b>12 DC 48V</b><br/>Connect the optional 48V DC power supply to this receptacle.</p> |
|--------------------------------------------------------------------------------------------------------------------------------------------------------------------------------------------------------------------------------------------------------------------------------------------------------------------------------------------------------------------------------------------------------------------------------------------------------------------------------------------------------------------------------------------------------------------------------------------------------------------------------------------------------------------------------------------------------------------------------------------------------------------------------------------------------------|----------------------------------------------------------------------------------------------------------------------------------------------------------------------------------------------------------------------------------------------------------------------------------------------------------------------------------------------------------------------------------------------------------------------------------------------------------------------------------------------------------------------------------------------------------------------------------------------------------------------------------------------------------------------------------------------------------------------------------------------------------------------------------------------------------|

# Installation

## RS-232

Both the AT-OMNI-111 and AT-OMNI-112 provide RS-232 over IP, allowing communication between an automation system and an RS-232 device. This step is optional.

1. Use wire strippers to remove a portion of the cable jacket.
2. Remove at least 3/16" (5 mm) from the insulation of the RX, TX, and GND wires.
3. Insert the TX, RX, and GND wires into correct terminal on the included Phoenix block. If using non-tinned stranded wire, press the orange tab, above the terminal, while inserting the exposed wire. Repeat this step for the TX, RX, and GND connections.

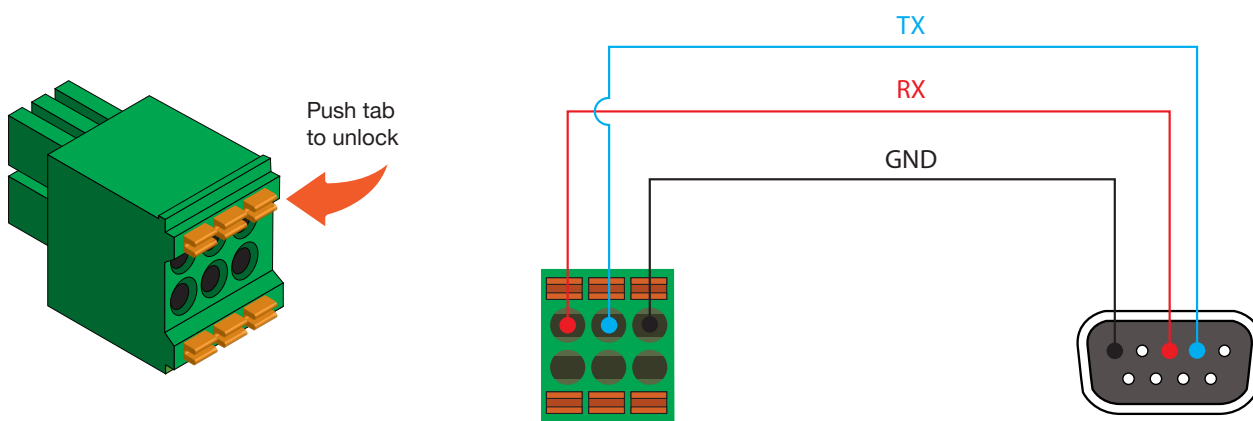

**NOTE:** Typical DB9 connectors use pin 2 for TX, pin 3 for RX, and pin 5 for ground. On some devices, pins 2 and 3 are reversed.

## Connection Instructions

1. Connect an Ethernet cable from the **Eth** port on the encoder to a PoE-capable switch on the Local Area Network (LAN). If using the dual-channel encoder, connect a separate Ethernet cables to **Eth 1** and **Eth 2** ports.



**IMPORTANT:** If a PoE-capable switch is not available, then the 48V DC power supply (sold separately) must be connected to the encoder.

2. Connect an HDMI cable from each source to the **HDMI** ports on the encoder.
3. RS-232 (optional)
  - Connect the RS-232 controller/automation system to the **RS-232** port on the encoder.
  - Connect the RS-232 device to the **RS-232** port on the decoder.
4. Once power is applied, the **PWR** indicator, on the front panel, will turn red, then amber, then green.

### Connection Diagram

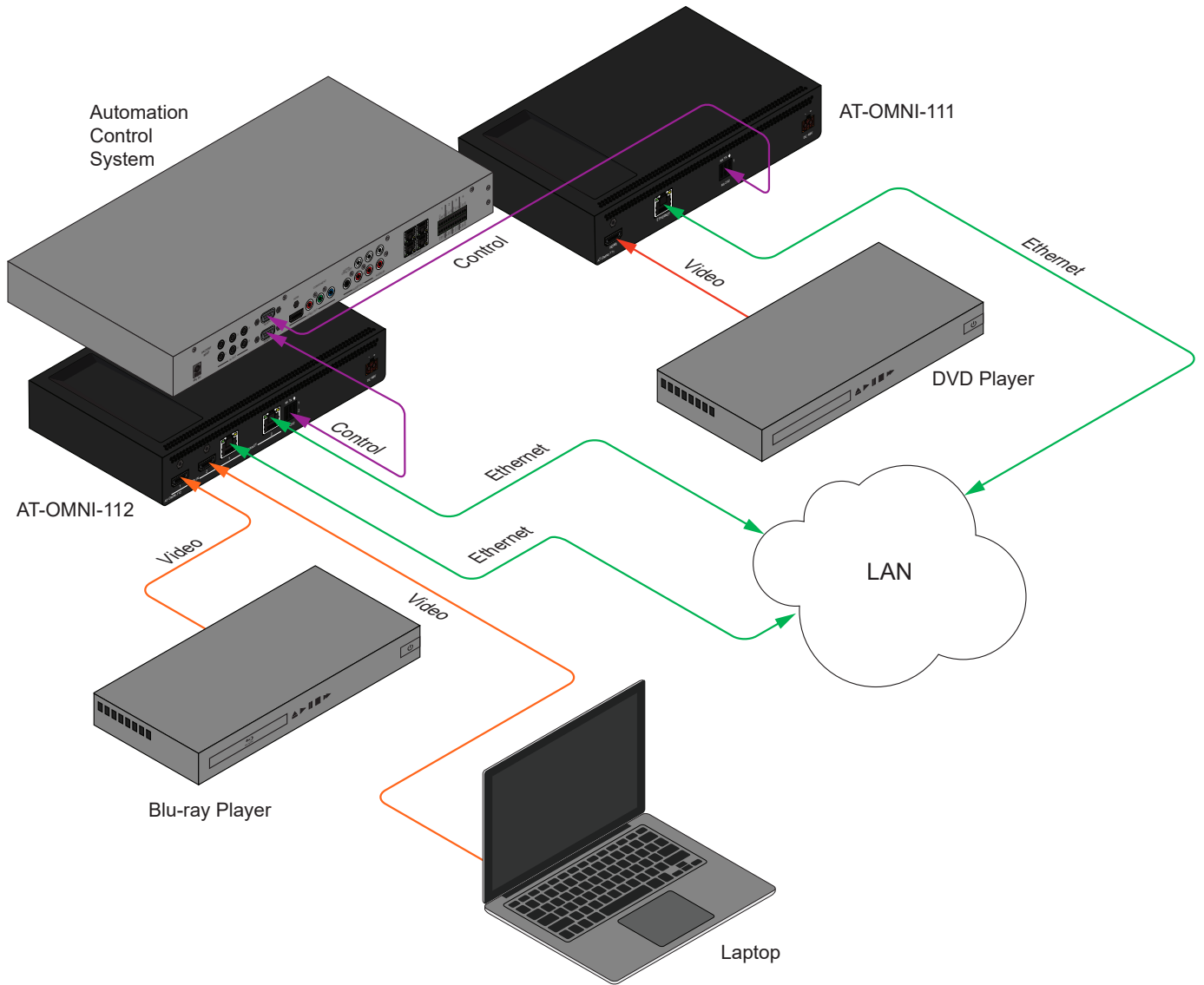

# Configuration

## Discovery using AMS

To determine the IP address of the encoder, use AMS. AMS is available only for the Windows® Operating System. If necessary, mDNS/Bonjour can also be used to discover the IP address of the encoder.

By default, OmniStream products are set to DHCP mode, allowing a DHCP server (if present) to assign each encoder/decoder an IP address. Once an IP address has been assigned, the Atlona Management System (AMS) can be used to manage the product on the network. AMS will only be able to discover encoders if they are on the same VLAN.

If a DHCP server is not found within 60 seconds, the encoder will be placed in Auto IP mode and assigned an IP address within the range of 169.254.xxx.xxx. If this occurs, configure the network interface of the computer that is running AMS, located on the same subnet (169.254.xxx.xxx, subnet mask 255.255.0.0). Refer to [Configuring a Static IP Address \(page 16\)](#) for more information on configuring an encoder in Auto IP mode.

1. Launch the Atlona Management System from the Windows Desktop or from the Start Menu.
2. After the AMS server starts, click the **OK** button to dismiss the dialog.

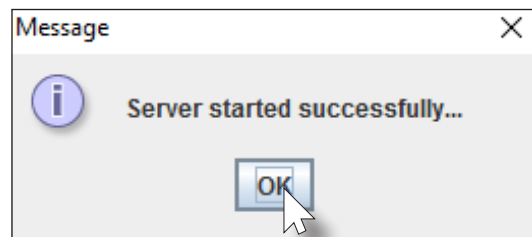
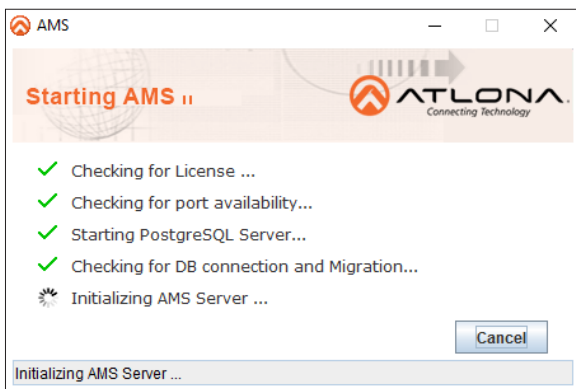

3. Launch a web browser and type localhost:8080 in the address bar, as shown below.



4. Enter the login information on the AMS web page, then click the **Login** button. Note that the password is masked when typed.

Login: admin  
 Password: admin123

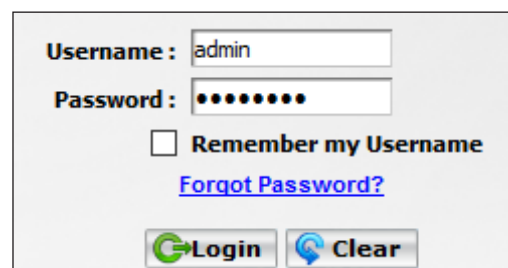
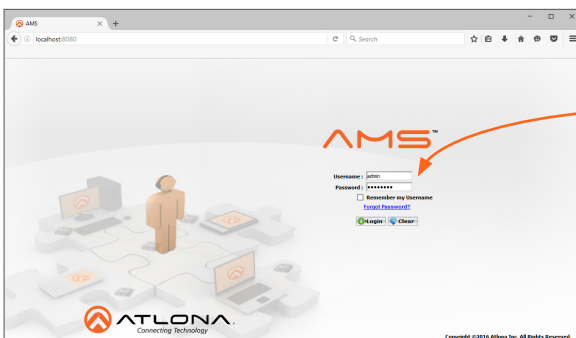

5. Under the **Domain View**, locate the IP address for the encoder. Single-channel encoders will be labeled as **OMNI-111**. Dual-channel encoders will be labeled as **OMNI-112**.

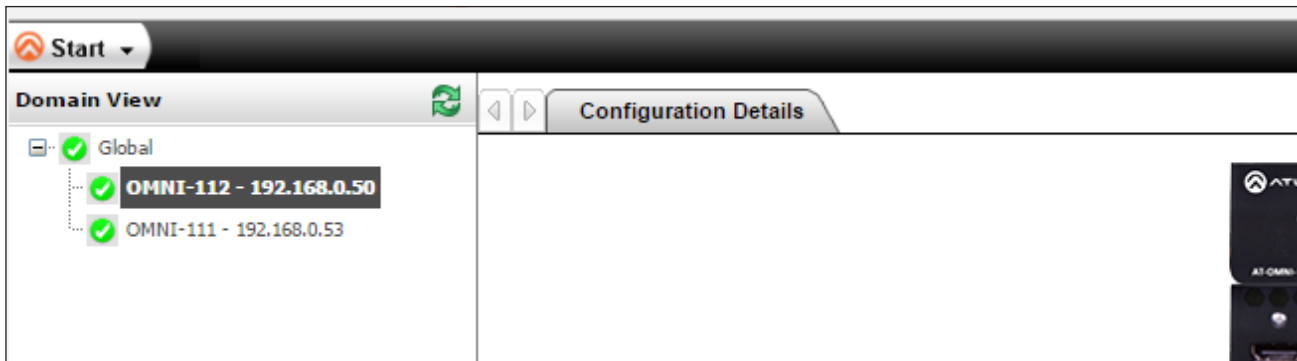

If no OmniStream devices are found, then make sure that both the encoder and the computer that is running AMS are on the same subnet.



**IMPORTANT:** OmniStream uses mDNS as the discovery mechanism. In order for mDNS to function properly, there must not be restrictions applied to the network. VPN can be used to connect to a computer that is running AMS, on the same network. However, VPN cannot be used when AMS is running on the local machine.

6. If, after verifying the above restrictions, no OmniStream devices are listed under the **Domain View**, then follow the procedure below.
  - a. Make sure that both the encoder and the computer that is running AMS are on the same subnet.
  - b. Remove any network restrictions that may be in place.
  - c. In AMS, click **Start > Add Device > Auto > Stop mDNS Discovery**. This feature is enabled, by default.

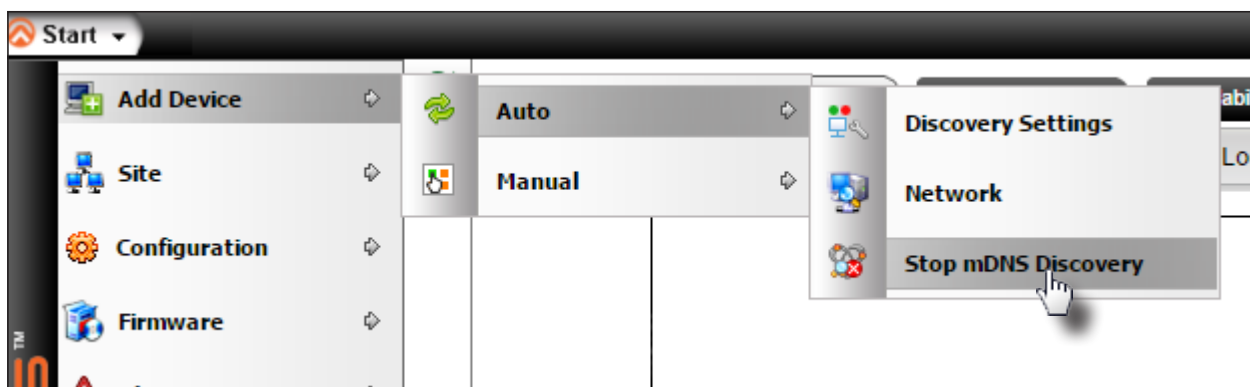

- d. After a few moments, the following message box will be displayed. Click the **OK** button to dismiss the message box.

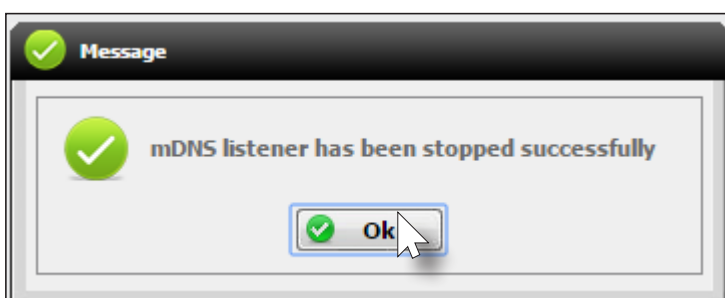

- e. Restart the mDNS listener by clicking **Start > Add Device > Auto > Start mDNS Discovery**.
- f. After the mDNS listener is enabled, click the OK button to dismiss the message box.
- g. The list of OmniStream devices should now be listed under the **Domain View** pane.

## Configuring a Static IP Address

The following section is only required to set an encoder, currently in Auto IP mode, to a static IP address. If a DHCP server is not found within 60 seconds, encoders are automatically placed in Auto IP mode and will be assigned an IP address within the range 169.254.xxx.xxx. If this occurs, a static IP address can be assigned to the encoder in order for AMS to locate it on the network.

1. Make sure that the encoder is powered. Power will need to be supplied either by the external 48V power supply (not included) or by connecting an Ethernet cable from the encoder to a PoE-capable switch. If using the AT-OMNI-112, the Ethernet cable can be connected to either **Eth 1** or **Eth 2**.
2. Connect an Ethernet cable from the PC, directly to one of the Ethernet ports on the encoder. Make sure that the computer being used has AMS installed.
3. Click **Start > Settings > Control Panel > Network and Sharing Center**.
4. Click **Change adapter settings**.
5. Right-click on the adapter that is used to establish a wired connection to the network, and select **Properties** from the context menu.
6. Under the **Ethernet Properties** dialog box, select **Internet Protocol Version 4** and then click the **Properties** button.
7. Click the **Use the following IP address** radio button.



**IMPORTANT:** Before continuing, write down the current IP settings in order to restore them, later. If *Obtain an IP address automatically* and *Obtain DNS server automatically* are selected, then this step is not required.

8. Enter the desired static IP address or the IP address provided by the network administrator.

If the PC does not require Internet access or if a statically-assigned IP address is being used, then an IP address of 169.254.xxx.xxx can be entered.

9. Set the subnet mask to 255.255.0.0.
10. Click the **OK** button then close all **Control Panel** windows.
11. Launch AMS.
12. Locate the encoder under the **Domain View** of AMS. Single-channel encoders will be labeled as **OMNI-111**. Dual-channel encoders will be labeled as **OMNI-112**.

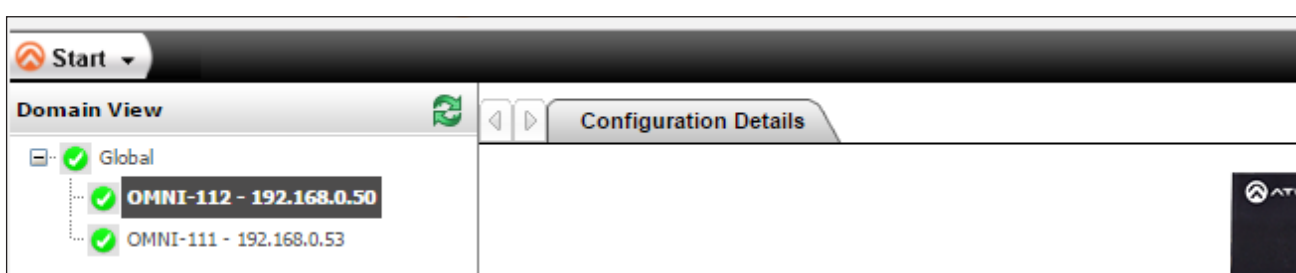



13. Under the **Configuration Details** tab, locate the **Network** tab.

<b>System Information</b>	
<b>Input</b>	
<b>Encoding</b>	
<b>Serial</b>	
<b>Session</b>	
<b>Logo</b>	
<b>Alarms</b>	
<b>Network</b>	
<b>Users</b>	
<b>License</b>	
<b>Demo</b>	

Network 1	
<b>Name</b>	eth1
<b>Enabled</b>	true
<b>Carrier</b>	false
<b>Mode</b>	<input checked="" type="radio"/> DHCP <input type="radio"/> Static
<b>IP Address</b>	192.168.11.76
<b>Subnet</b>	255.255.255.0
<b>Gateway</b>	192.168.11.1
<b>Link Speed</b>	10
<b>MAC Address</b>	B8:98:B0:01:87:A9

Network 2	
<b>Name</b>	eth2
<b>Enabled</b>	true
<b>Carrier</b>	true
<b>Mode</b>	<input type="radio"/> DHCP <input checked="" type="radio"/> Static

14. Enter the required network information for the encoder in the **IP Address**, **Subnet**, and **Gateway** fields.

15. Click the **Save** button in the bottom-right corner, to apply the changes.

16. Disconnect the encoder from the PC and connect it to the network.

17. The encoder is now ready for use.

## Manual Setup

The following section is *optional* and should *only* be performed if manual configuration of each encoder is desired. AMS automatically configures OmniStream products once they are connected to the network.

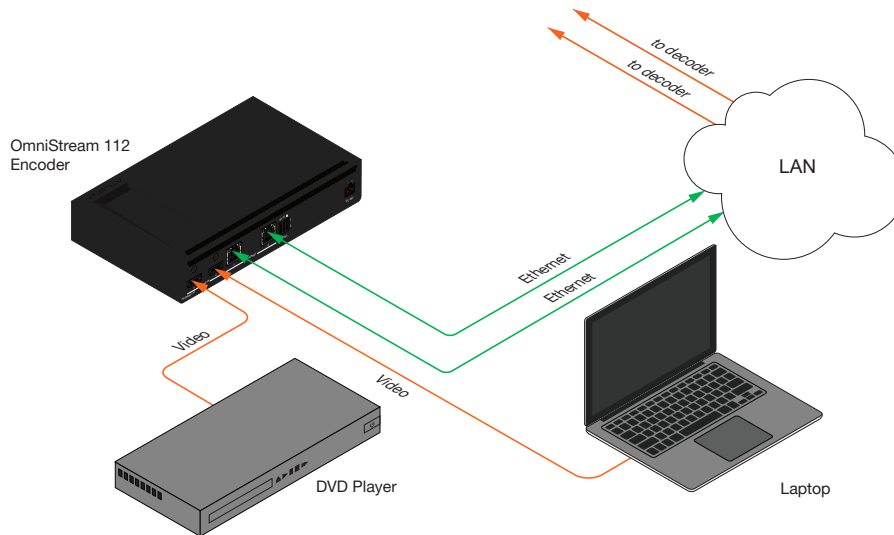

### Checking the Input

1. Select the desired encoder under the **Domain View** pane, within AMS.
2. Under the **Configuration Details** tab, click the **Input** tab.

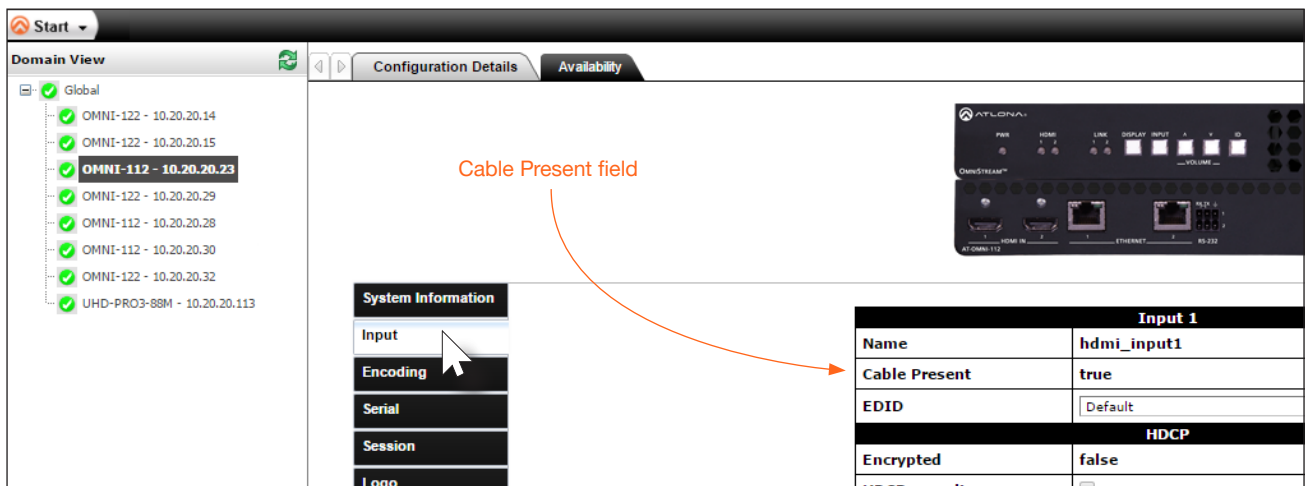

Input 1	
Name	hdmi_input1
Cable Present	true
EDID	Default
HDCP	
Encrypted	false

3. Check the **Cable Present** field. If a cable is connected from a source to an input on the encoder, then this field will be set to true. If no cable is connected, then this field will be set to false.

Note that this field may also reflect the integrity of the cable: if the cable is bad or does not maintain a secure connection, then the **Cable Present** field may also be set to false.

## Input Selection

1. Select the desired encoder under the **Domain View** pane, within AMS.
2. Under the **Configuration Details** tab, click the **Encoding** tab.

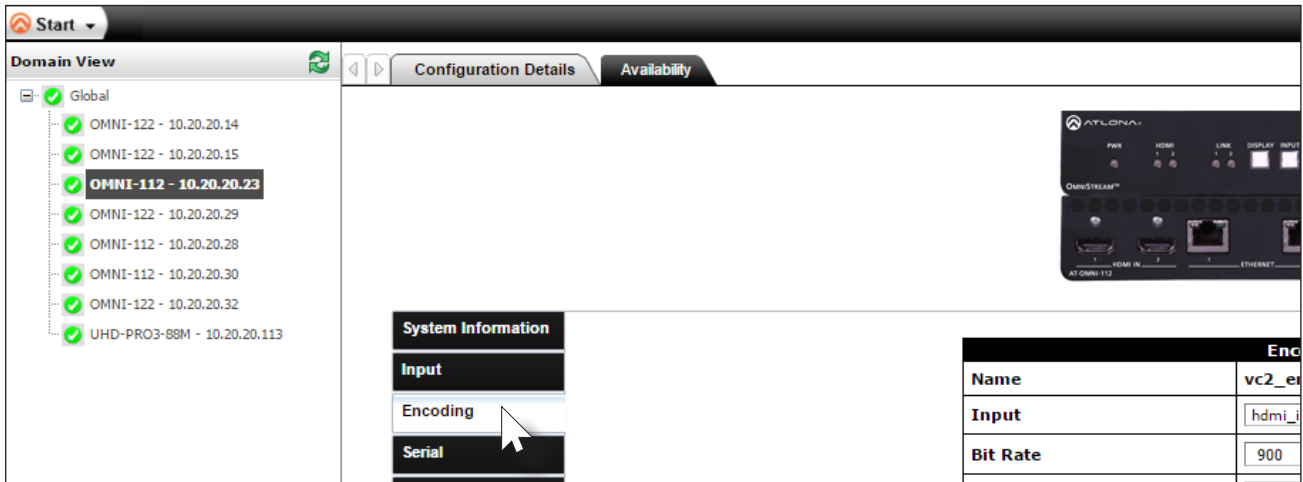

3. Click the **Input** drop-down list and select the input for the desired source.

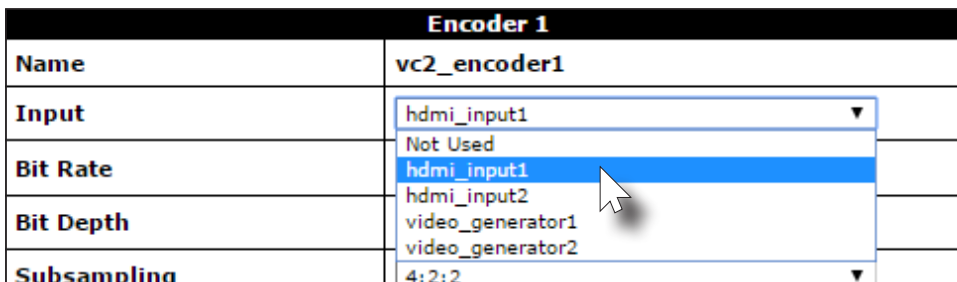

hdmi\_input1 = HDMI IN 1  
hdmi\_input2 = HDMI IN 2

4. Enter the desired bit rate in the **Bit Rate** field. Specifying lower bit rates will reduce video quality. This value is in megabits-per-second (Mbps).

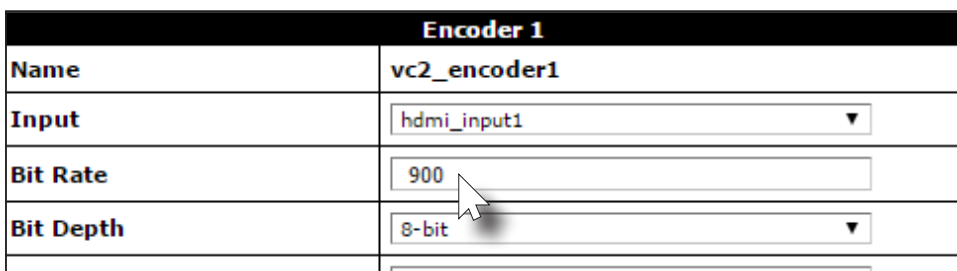

5. Select the bit depth from the **Bit Depth** drop-down list.

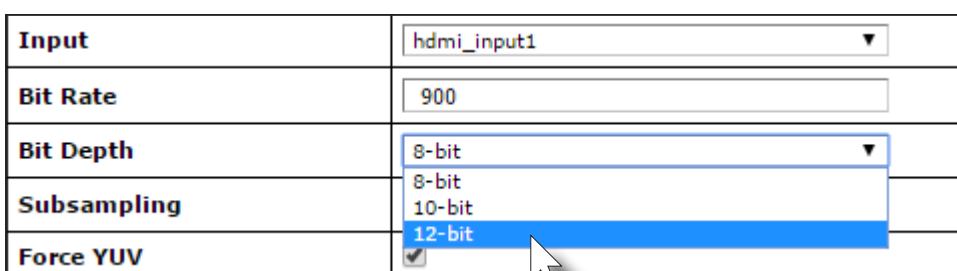

6. Select the subsampling value from the **Subsampling** drop-down list.

<b>Bit Rate</b>	900
<b>Bit Depth</b>	8-bit
<b>Subsampling</b>	4:2:2
<b>Force YUV</b>	<input type="checkbox"/>
<b>Encoder 2</b>	

7. Click the **Force YUV** checkbox to use YUV color space. Click this checkbox to force the output of the encoder to output YUV regardless of whether the input is RGB or YUV. In order for the chroma scaling to work on RGB inputs, this option must be selected.

<b>Name</b>	vc2_encoder1
<b>Input</b>	hdmi_input1
<b>Bit Rate</b>	900
<b>Bit Depth</b>	8-bit
<b>Subsampling</b>	4:2:2
<b>Force YUV</b>	<input checked="" type="checkbox"/>

**Dual-channel encoder only:**

8. Repeat steps 3 through 7 for the **Encoder 2** section. If a secondary HDMI source is not connected, then these fields may be left at their current settings. The **Encoder 2** block will only be available when using a dual-channel encoder (AT-OMNI-112).

**Dual-channel / single-channel encoder:**

9. Click the **Save** button, near the bottom of the page, to save all changes.

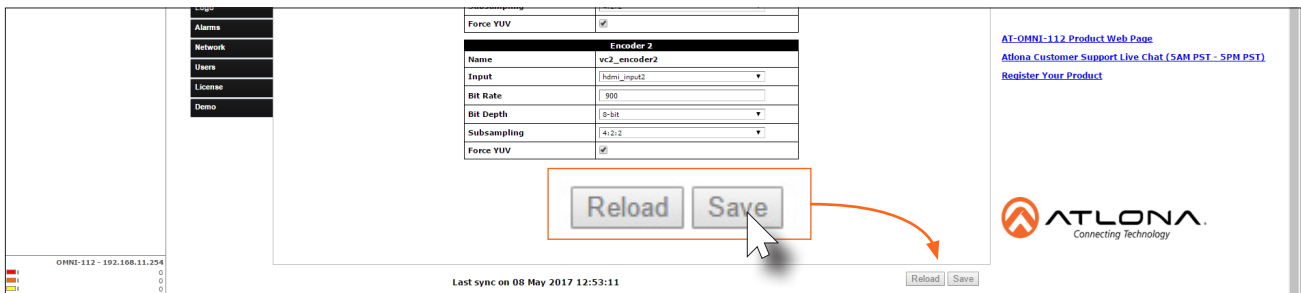

The screenshot shows the configuration page for the AT-OMNI-112. On the left is a navigation menu with options: Alarms, Network, Users, License, and Demo. The main content area displays the configuration for 'Encoder 2' with the following settings: Name: vc2\_encoder2, Input: hdmi\_input2, Bit Rate: 900, Bit Depth: 8-bit, Subsampling: 4:2:2, and Force YUV: checked. At the bottom of the configuration area, there are 'Reload' and 'Save' buttons. An orange arrow points from the 'Save' button to the AT-OMNI-112 logo in the bottom right corner. The footer of the page includes the text 'Last sync on 08 May 2017 12:53:11' and another set of 'Reload' and 'Save' buttons.

10. Once changes have been successfully applied, a message box will be displayed indicating that all changes were updated. Click the **OK** button to dismiss the message box.

## Session Configuration

Once the inputs have been assigned to the desired source, the next step is to configure each session. A *session* is primarily a multicast IP address that is assigned to an AV stream. When each stream is configured for bit rates less than 450 Mbps (only recommended for 1080p and lower resolutions), a single Ethernet cable can transport two sessions. The dual-channel encoder supports up to four sessions to enable redundancy for dual 1080p-use cases. The single-channel encoder supports a maximum of two sessions to enable redundancy for single 1080p-use cases.

1. Select the desired encoder under the **Domain View** pane, within AMS.
2. Click the **Session** tab. The **Session 1** tab will be active, by default.

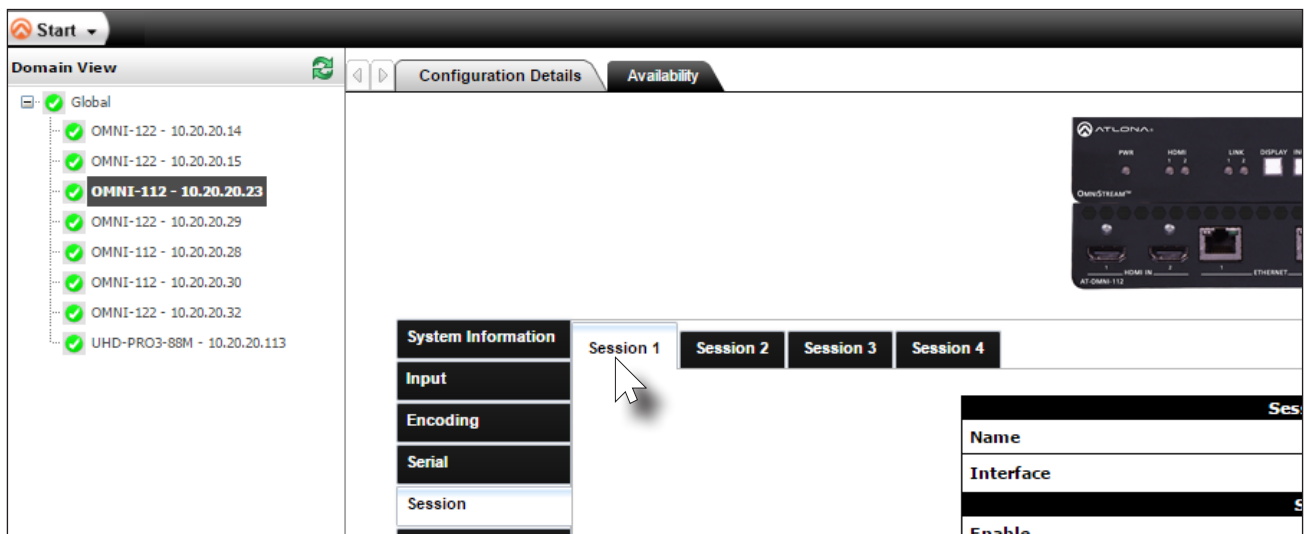

3. Under the **Session 1** block, select the desired interface from the **Interface** drop-down list.

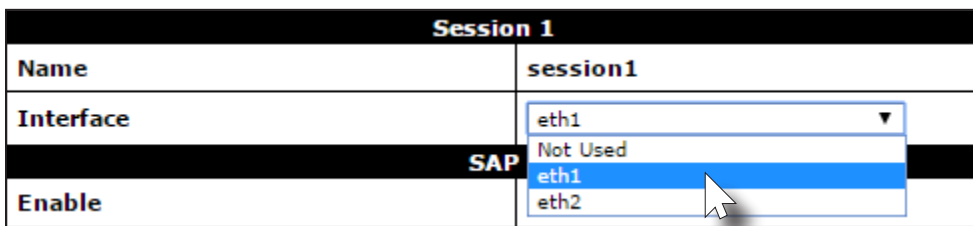

4. Under the **Video** block, select the desired encoder session from the **Encoder** drop-down list. If no encoder will be assigned to the session, select the **Not Used** option.

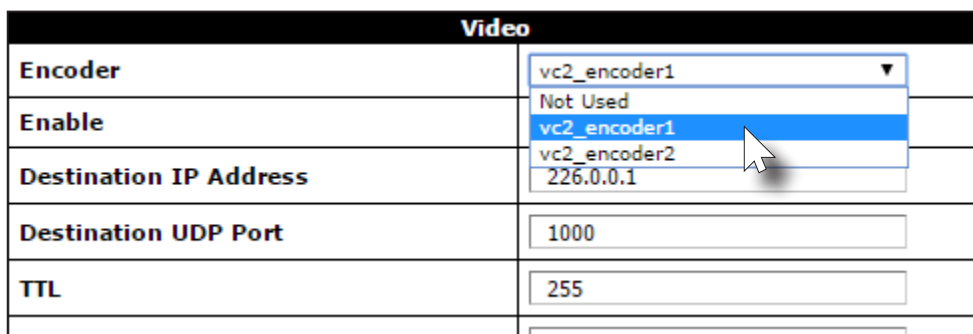

If the **Video** block is not visible, use the scroll bar on the right side of the screen to scroll up or down.

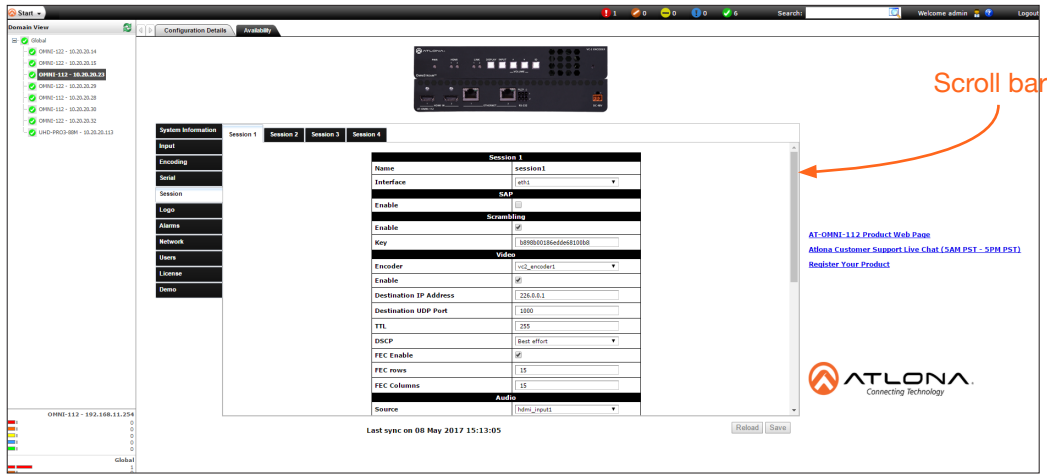

Note that the available selections in the **Encoder** drop-down list are the same names that are assigned to each encoder block, under the **Encoding** tab: `vc2_encoder1` is assigned to `hdmi_input1` and `vc2_encoder2` is assigned to `hdmi_input2`.

### Session tab

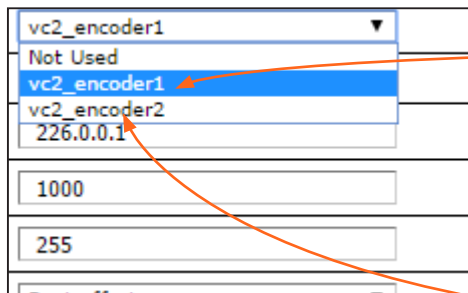

### Encoding tab

Encoder 1	
Name	vc2_encoder1
Input	hdmi_input1
Bit Rate	900
Bit Depth	8-bit
Subsampling	4:2:2
Force YUV	<input checked="" type="checkbox"/>
Encoder 2	
Name	vc2_encoder2
Input	hdmi_input2

5. Make sure that the checkbox next to **Enabled** is checked. To disable video, at any time, click the checkbox to remove the check mark.
6. Enter the destination multicast IP address in the **Destination IP Address** field. By default, AMS will automatically populate this field.
7. Enter the port number in the **Destination UDP Port** field.

Video	
Encoder	vc2_encoder1
Enable	<input checked="" type="checkbox"/>
Destination IP Address	226.0.0.1
Destination UDP Port	1000
TTL	255

Video enabled

- Scroll down to the **Audio** block and select the audio source from the **Source** drop-down list. Note that source and port information can be modified based on the application requirements.



**IMPORTANT:** AMS does not allow the same port numbers to be used on both video and audio. Always specify unique ports for both video and audio.

Audio	
Source	hdmi_input1
Enable	<input type="checkbox"/>
Destination IP Address	226.0.0.8
Destination UDP Port	1100
TTL	255
DSCP	Best effort
FEC Enable	<input type="checkbox"/>
FEC rows	4

- Make sure that the checkbox next to **Enabled** is checked. To disable audio, at any time, click the checkbox to remove the check mark.
- Enter the destination multicast IP address in the **Destination IP Address** field. By default, AMS will automatically populate this field.
- Enter the port number in the **Destination UDP Port** field.

Audio	
Source	hdmi_input1
Enable	<input checked="" type="checkbox"/>
Destination IP Address	226.0.0.8
Destination UDP Port	1100
TTL	255
DSCP	Best effort

- Under the **AUX** block, select the type of control from the **Source** drop-down list. This selection will be the method used for transmitting commands. See the next page for more information.

AUX	
Source	serial_port1
Enable	<input type="checkbox"/>
Destination IP Address	226.0.0.9
Destination UDP Port	1200
TTL	255
DSCP	Best effort

Source	Description
Commands	Commands are sent using CEC (over HDMI)
serial_port1	Commands are transmitted using Serial Port 1
serial_port2	Commands are transmitted using Serial Port 2

14. If using control, make sure that the checkbox next to **Enabled** is checked. To disable control, click the checkbox to remove the check mark.
15. Enter the destination multicast IP address in the **Destination IP Address** field. By default, AMS will automatically populate this field.
16. Enter the port number in the **Destination UDP Port** field.
17. Repeat steps 3 through 16 for each **Session** tab, as required. When using single-channel encoders, only two **Session** tabs will be available.
18. Click the **Save** button, near the bottom of the page, to save all changes.
19. Once changes have been successfully applied, a message box will be displayed indicating that all changes were updated. Click the **OK** button to dismiss the message box.
20. Basic configuration is complete.



## Front Panel Controls

### Rebooting OmniStream

To reboot the OmniStream encoder, press and release the recessed button, on the far-right side of the unit, using a small, pointed object. Rebooting the encoder does not reset the encoder to factory-default settings.

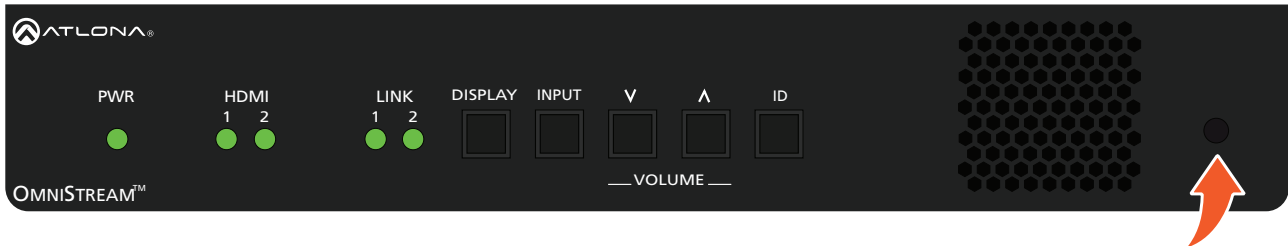

### Selecting the Input

This feature is not available on the single-channel OmniStream encoder (AT-OMNI-111).

Press and release the **INPUT** button to select the desired input: **HDMI 1** or **HDMI 2**. When a new active input is selected, the previous input will remain “live”. This will allow connected devices, such as laptop computers, to remain in “presentation mode” and not revert to single-screen mode.

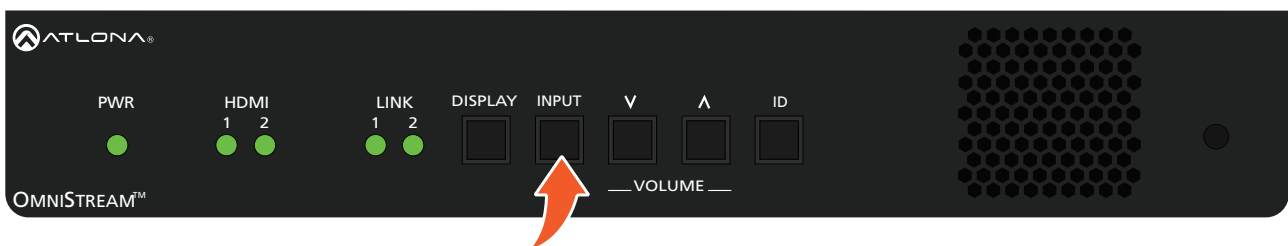

### Powering the Display

This feature is not available on the single-channel OmniStream encoder (AT-OMNI-111).

Press and release the **DISPLAY** button to send the command to the toggle power on the display that is connected to the decoder. The command is sent over IP. After the decoder receives the command, it is executed and transmitted to the display using RS-232 and/or CEC.

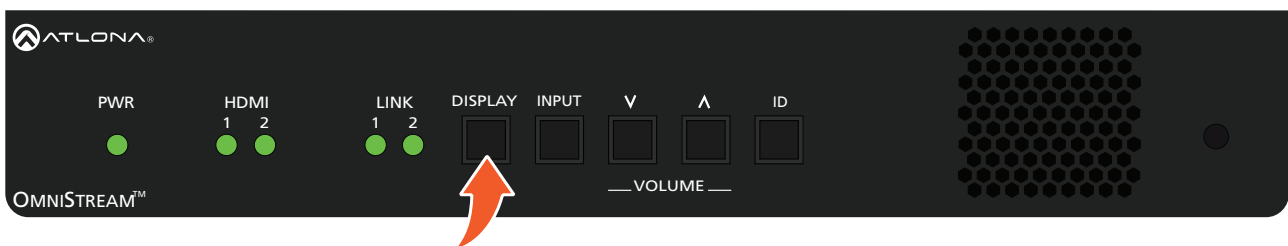

### Adjusting Volume

This feature is not available on the single-channel OmniStream encoder (AT-OMNI-111).

Press and release the **▲** (up) or **▼** (down) **VOLUME** buttons to increase or decrease the audio volume, respectively, in 1 dB increments. The volume command is sent over IP. After the decoder receives the command, it is executed and transmitted to the display using RS-232 and/or CEC. These buttons also concurrently affect the analog output port volume. The maximum audio level is +15 dB.

When either of these buttons are pressed, the associated HDMI indicator, on the front panel, will glow bright orange to indicate that the stream is being controlled.

Press and hold either of these buttons to rapidly increase or decrease the volume.

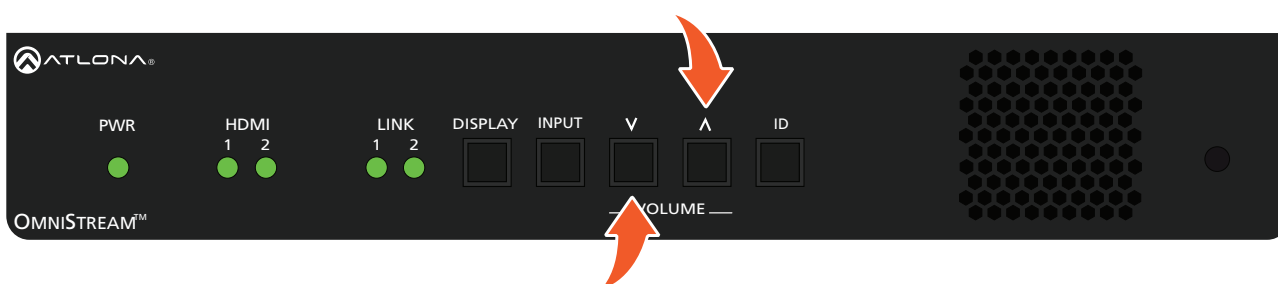

Depending upon the output mode of the encoder, the **VOLUME** buttons will behave differently.

#### Single-output Mode

Press the desired **VOLUME** control button to immediately change the volume on the display.

#### Dual-output Mode

OmniStream does not currently provide a method for indicating the currently-controlled stream. To select a stream, the **INPUT** button must first be pressed.

1. Press and release the **INPUT** button.
2. The **HDMI** indicator will switch to the opposite stream.
  - If the HDMI indicator highlights the desired stream, then press the **VOLUME** buttons to adjust the audio output as desired.
  - If HDMI indicator does not highlight the desired stream, press the **INPUT** button to switch to the opposite stream, then press the **VOLUME** buttons to adjust the audio output as desired.

The example below, shows the result after initially pressing the **INPUT** button. The illustration below, shows the **HDMI 2** indicator glowing bright orange, signaling that **HDMI 2** is the stream that will be controlled.

If **HDMI 1** is desired, press and release the **INPUT** button.

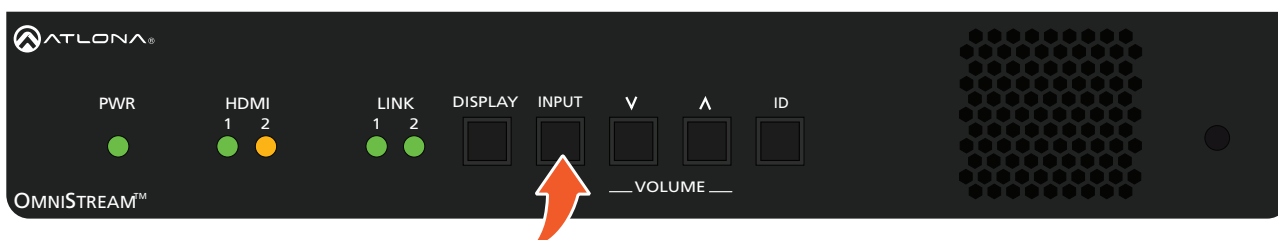

## ID Button

This feature is not available on the single-channel OmniStream encoder (AT-OMNI-111).

The ID button serves two functions:

1. Sends a broadcast message, over the network, to any devices that may be listening.
2. Resets the encoder to factory-default settings.

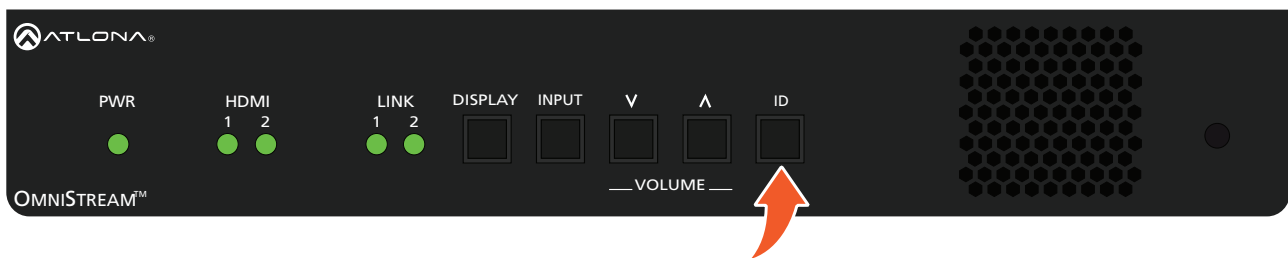

### Broadcast Messaging

Press and release the **ID** button to send a broadcast notification over the network to any devices that may be listening. As of AMS 1.7.0, this feature is not supported in AMS, but will be added in a future revision.

### Reset to Factory-Default Settings.

1. Press and hold the **ID** button for approximately 30 seconds.
2. The LED indicators on the front panel will flash, then turn “off.”
3. The encoder is now reset and will need to be reconfigured.



**WARNING:** Performing a factory-default reset will erase all user-programmed settings from the encoder. IP settings are not preserved.

# The Virtual Matrix

## Accessing the Virtual Matrix

1. Click the **Global** node, under the **Domain View** pane, within AMS.



2. Click the **Virtual Matrix** tab in the top portion of the screen.

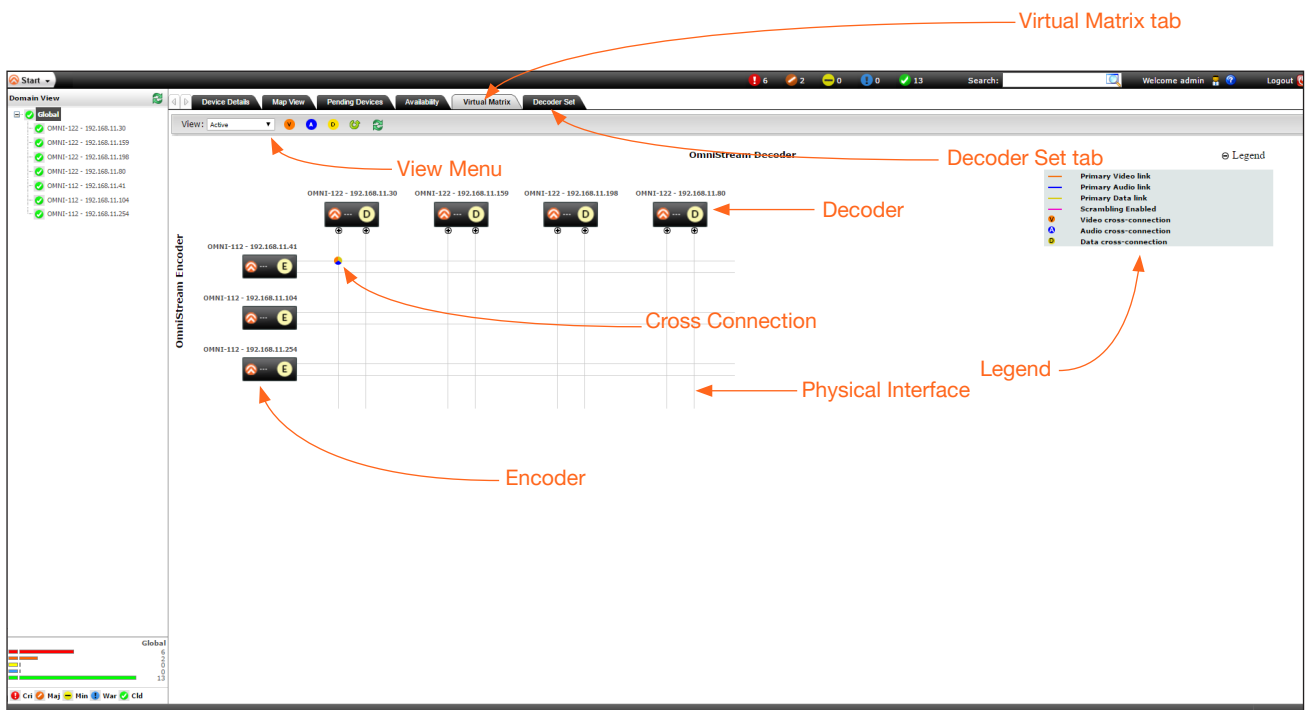

## Layout

The illustration, above, shows a single encoder and decoder. Note that the number of OmniStream devices under the **Virtual Matrix** tab and the **Domain View** pane are the same.

- Encoders are identified with an **E** and are displayed as rows.
- Decoders are identified with a **D** and are displayed as columns.
- Each encoder and decoder is labeled with the model and current IP address.
- *Physical interfaces* are represented by light-gray lines. These lines represent the Ethernet cables which carry video/audio data from an encoder to a decoder.
- *Cross connections* are a logical connection between two *physical interfaces* and are represented by a circular symbol.
- Click the + sign, next to Legend, to view a list of icons and line types used to represent items in the Virtual Matrix.

The View menu provides control over what signal types are displayed in the Virtual Matrix.

- Click the View drop-down list to select which video streams are displayed.

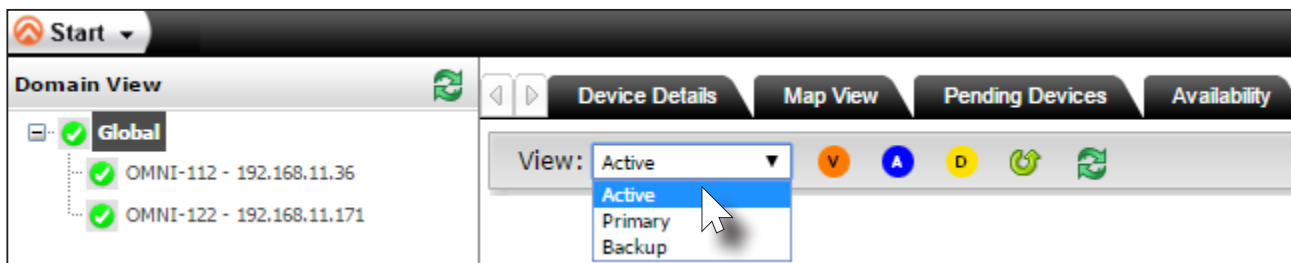

Type	Description
Active	All active streams are displayed. This is the default setting.
Primary	Displays only the primary streams.
Backup	Displays only the backup streams.

- Click the View the **V**, **A**, and **D** menu icons to only display video, audio, or data streams.

The illustration on the left shows a *cross connection* with video, audio, and data. By clicking the **V** button in the View menu, only the video signal is displayed. If multiple cross connections existed, this operation would apply to all nodes. To hide the video stream and return to the normal view, click the **V** button again.

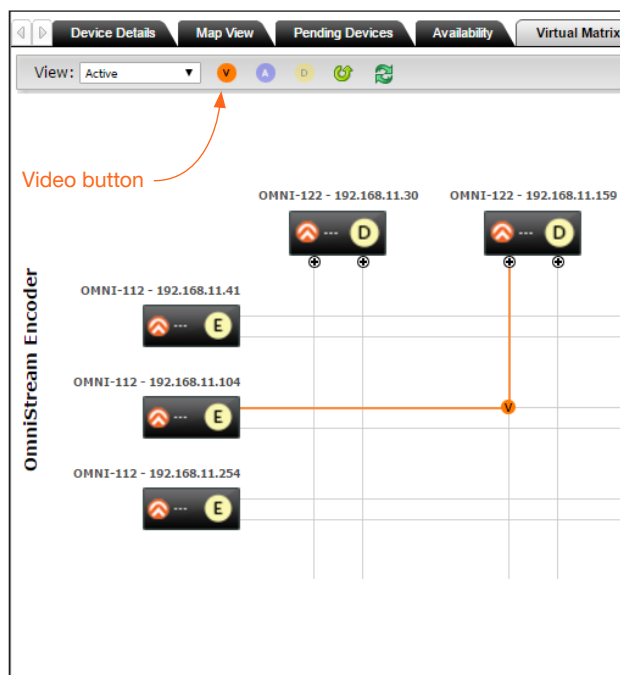
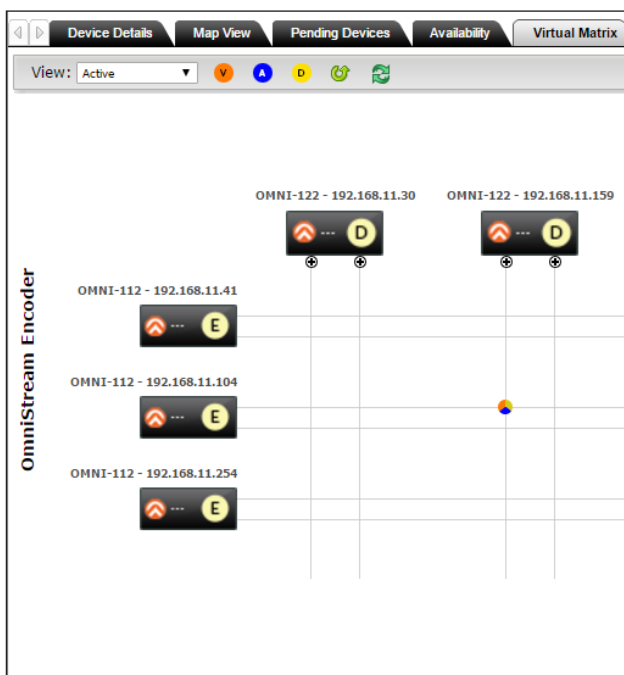

The Virtual Matrix provides a visual diagram of each encoder and decoder that has been detected by AMS. Each physical interface, source input, and display (sink) output, are arranged as follows, within the Virtual Matrix.

For the following, refer to *Figure 1*.

- On the *encoder*, Ethernet outputs are read from top-to-bottom: **ETHERNET 1** is in the top row. **ETHERNET 2** is in the bottom row.
- On the *decoder*, Ethernet inputs are read left-to-right: **ETHERNET 1** is in the first column and **ETHERNET 2** is in the second column.

*Figure 1*

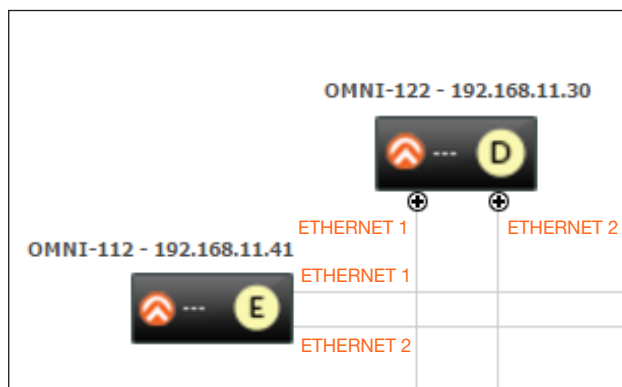



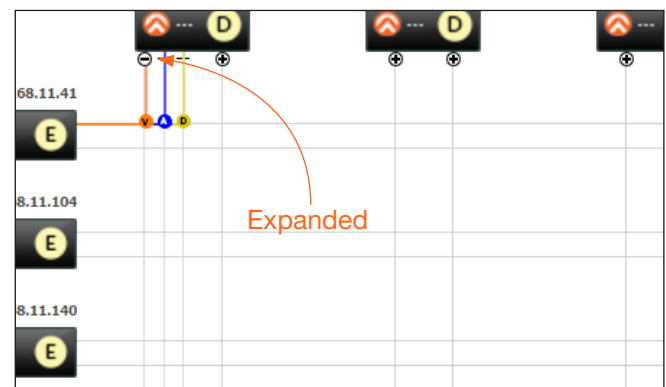

*Figure 2*



For the following, refer to *Figure 2*.

- Click the + icon, to expand the *physical interface*. When expanded, the icon will change to a minus ("-") symbol, and the all available signal types will be displayed. *Cross connections* are color-coded to provide information on what type of data is being passed between two *physical interfaces*.

Symbol	Description
	Video and audio
	Video only
	Audio only
	Data (auxiliary)
	Video + Audio + Data

## Physical Interfaces and Cross Connections

The following example provides a better understanding of how *physical interfaces* and *cross connections* work together.

Figure 3 shows a very simple setup: two sources are connected to a dual-channel encoder. Both Ethernet cables are connected from the encoder to the Local Area Network (LAN). Another set of Ethernet cables connects to a dual-channel decoder, somewhere on the same network. The Ethernet cables are the *physical interfaces* - that is, they provide a physical link - that allows the AV stream to be transported, over the network, from an encoder to a decoder endpoint.

Figure 3

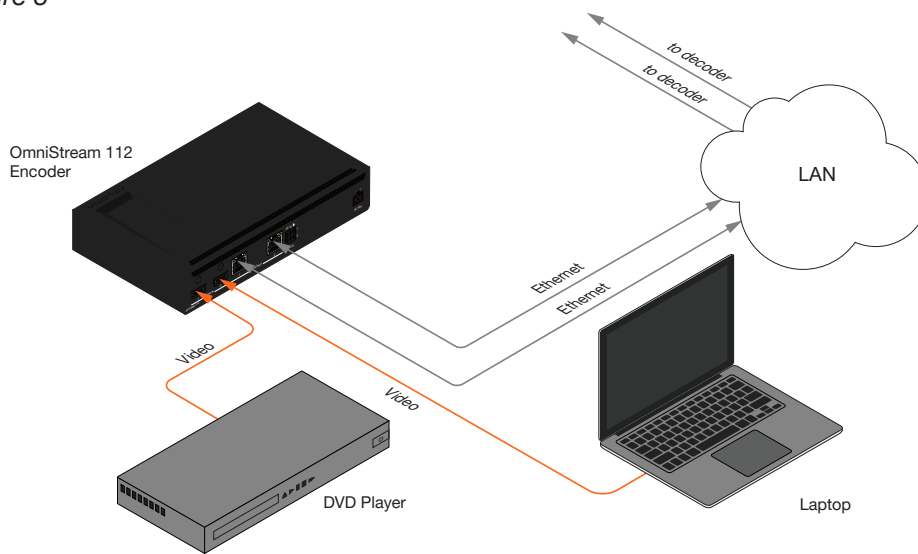

In Figure 3, the gray lines indicate that no signal is being sent from the encoder, over the Ethernet cables. Before a stream can be sent across the network, a *cross connection* must exist between two *physical interfaces*. *Cross connections* are created under the **Virtual Matrix** tab, in AMS. Figure 4a shows a *cross connection* that joins **Ethernet 1** on the encoder to **Ethernet 1** on the decoder. Figure 4b shows the result of the *cross connection* (green line) in the setup. Note that the second Ethernet line is still gray, indicating that the cross connection for this physical interface has not yet been created. Once a cross connection is created, the decoding process starts automatically.

Figure 4a

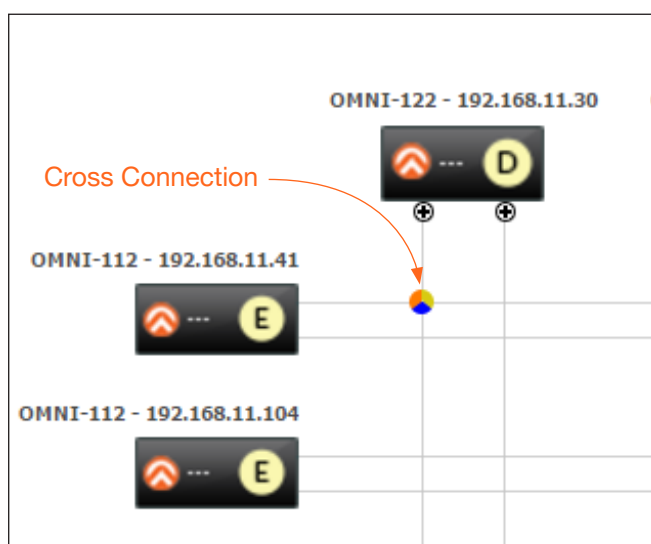
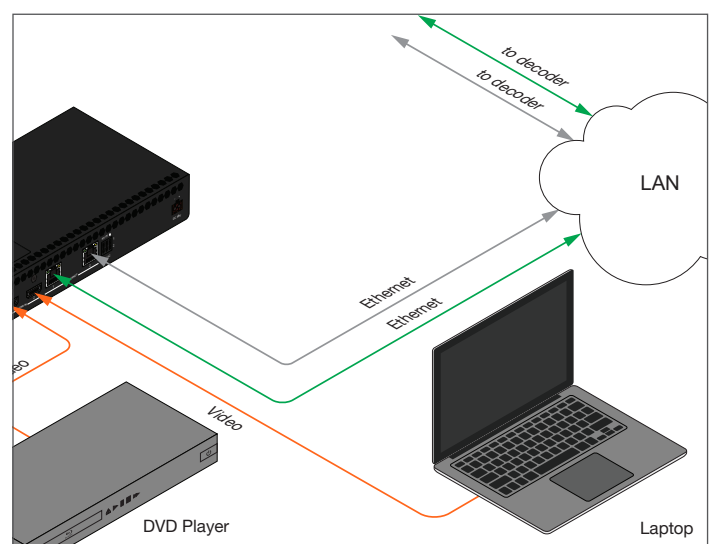

Figure 4b



## Creating Cross Connections

The term *physical interface*, refers to the Ethernet cable that is connected to each encoder/decoder. Once a *cross connection* is created, decoding process will automatically begin. To stop the decoding process, refer to [Removing Cross Connections \(page 35\)](#) for more information.

1. Move the mouse cursor over any two *physical interfaces*. When a valid selection is made, the cursor will turn from an arrow to a hand.

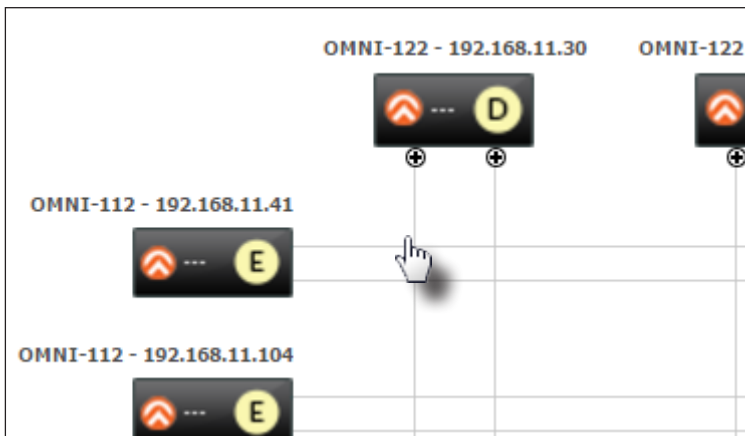

2. Left-click to display the **Create cross Connection** dialog. The current sources, as well as the assigned sessions, will be displayed. The default streaming mode is set to *multicast*. Note that only *sessions* assigned to the *physical interface* will appear in the drop-down lists.

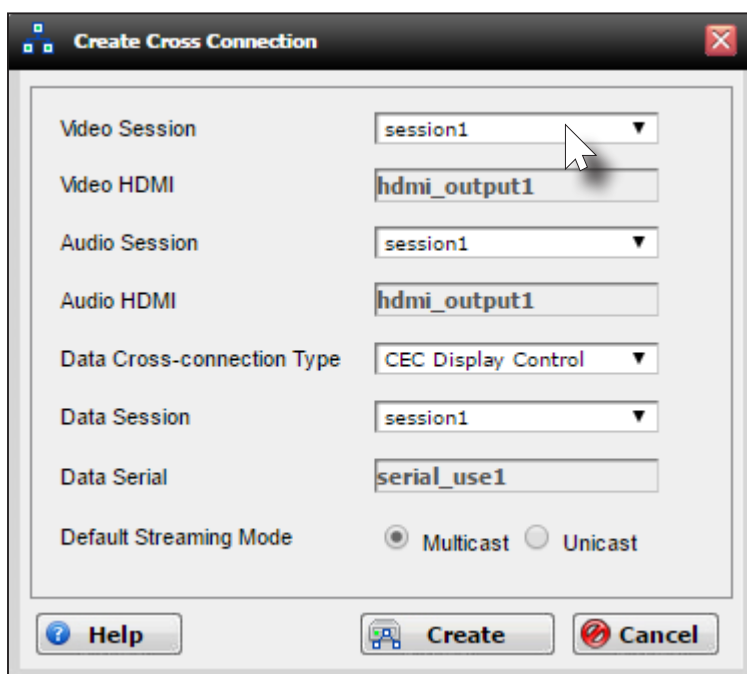

To select a different video session, click the **Video Session** drop-down list and select a different session. The same operation can be performed for the **Audio Session** and **Data Session**, using the drop-down lists. The default streaming mode is set to *multicast*.

If no control signals will be used, the **Data Cross-connection Type** drop down list should be set to Not Used.



- Click the **Create** button to create the cross connection.
- The following message box will be displayed. If the operation is successful, the dialog will state that a cross connections has been successfully created. The IP address in the message box is the decoder IP address.

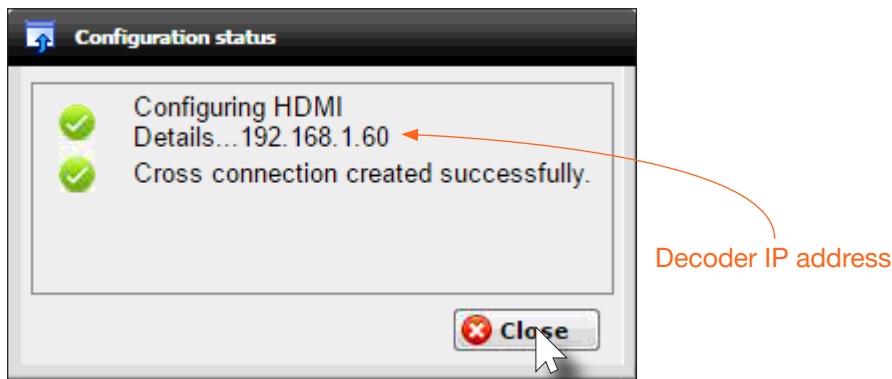

- Click the **Close** button to dismiss the message box.
- Once the *cross connection* is created, a circular symbol will appear at the point where the *physical interfaces* are connected.

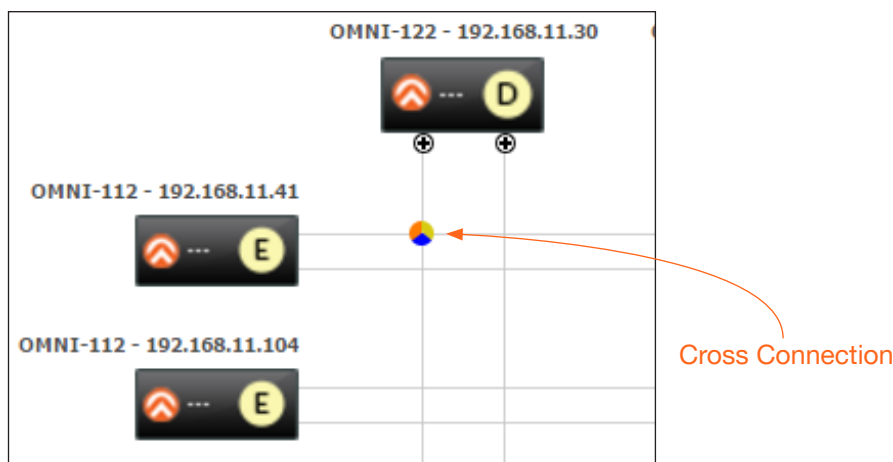

**NOTE:** The *cross connection* represents a “node” in which two *physical interfaces* are connected. However, a *cross connection* does not necessarily indicate the presence of a video/audio/data stream passing from the encoder to the decoder; it merely represents a logical connection between two *physical interfaces*.

### Data-Specific Cross Connections

Based on the data that is provided by the encoder, data-specific cross connections can also be created. For example, if an HDMI input contains both video and audio, but only a video data is desired, it is possible to create a cross connection that isolates the video signal.

1. Click the + icon, under the decoder icon, to expand the *physical interface*. When expanded, three gray lines will be displayed and the + icon will change to a minus ("-") symbol.
2. Move the mouse cursor over the desired data component within the *physical interface*. Each vertical line represents a different data stream. This order of each stream, from left to right, is constant for each *physical interface*, throughout the Virtual Matrix.

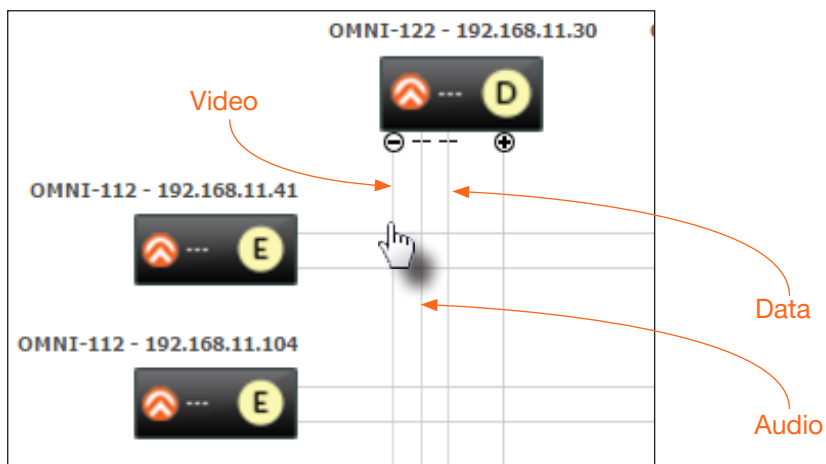

3. Left-click the desired data stream to display the **Create Cross Connection** dialog. In this example, the Video data stream is selected.

To select a different video session, click the **Video Session** drop-down list and select a different session. The default streaming mode is set to *multicast*.

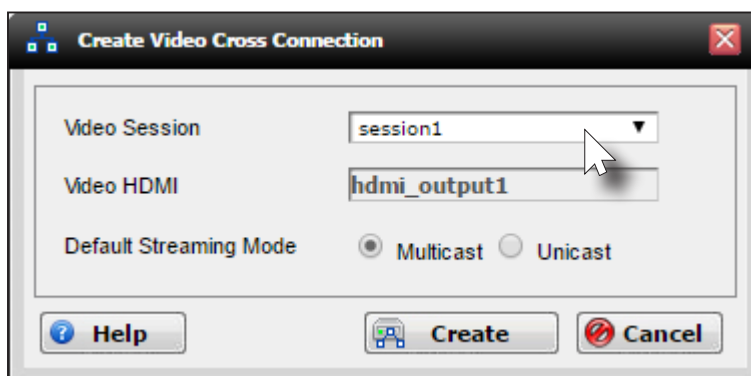

4. Select the **Default Streaming Mode** by clicking the desired radio button. By default, the streaming mode will be set to multicast.
5. Click the **Create** button to create the cross connection or click the **Cancel** button to abort the operation.

## Removing Cross Connections

Deleting a *cross connection* terminates the connection between two physical interfaces. Once deleted, the currently assigned video/audio stream will no longer be able to pass between the encoder and decoder.

1. Right-click on the desired *cross connection*.

Unless the desired cross connection is known, it will be necessary to right-click on the cross connection to display the available options. If **Start Decoding** is an option, then another cross connection must be selected.

2. Click **Remove Cross Connection** to delete the *cross connection*.

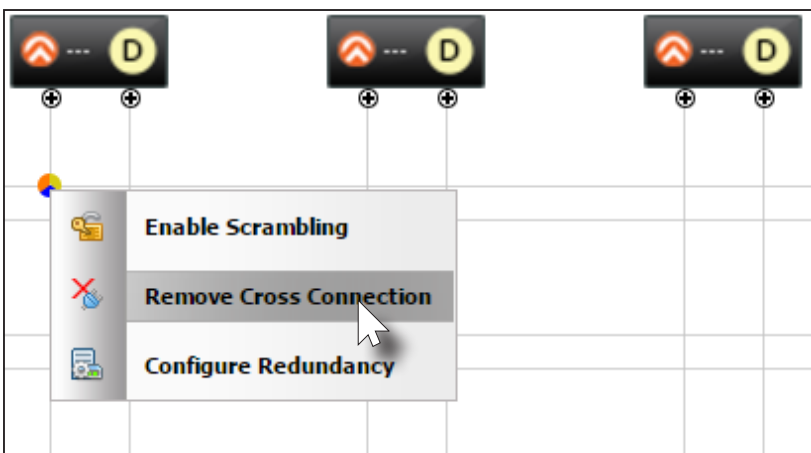

3. AMS will display a prompt message to confirm the operation. Click the **OK** button to delete the cross connection. Click the **Cancel** button to return to the **Virtual Matrix** tab without deleting the cross connection.

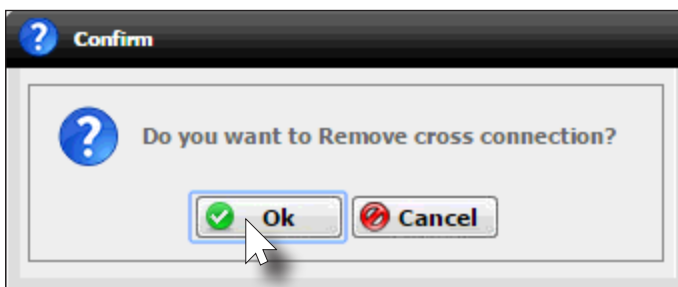

4. If the **OK** button is clicked, the following message box will be displayed. Click the **Close** button to dismiss the message box.

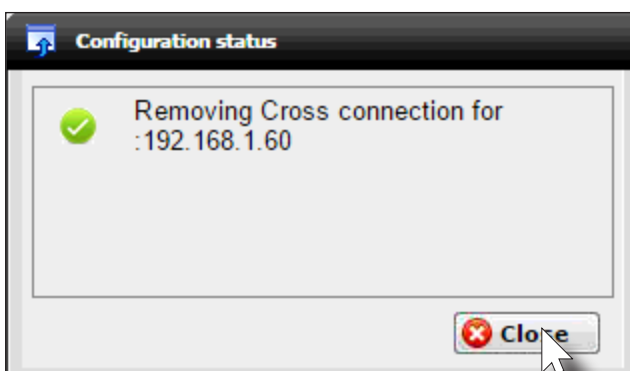

## Scrambling

OmniStream supports 128-bit Advanced Encryption Standard (AES) scrambling for both audio and video streams. Scrambling can be enabled or disabled through AMS, and can be individually applied to video, audio, or both. Scrambling can be enabled either before or after the decoding process is started. Data streams cannot be scrambled; only video and audio can be scrambled.

When scrambling is enabled, the scrambling key can be found under the **Session** tab on the encoder.

Session 1	
<b>Name</b>	session1
<b>Interface</b>	eth1
SAP	
<b>Enable</b>	<input type="checkbox"/>
Scrambling	
<b>Enable</b>	<input checked="" type="checkbox"/>
<b>Key</b>	b898b00186edde68100b8
Video	
<b>Encoder</b>	vc2_encoder1

Scrambling key (encoder)

When scrambling is enabled through the Virtual Matrix, the key is automatically generated and the **Enable Scrambling** box is checked. A user-defined key can also be created and placed in both the **Key** and **Scrambling Key** fields.



**NOTE:** If a user-defined key is specified, then it must be a minimum of 8 alphanumeric characters. Special characters and spaces are not permitted.

1. Right-click on the desired *cross connection*. If a *cross connection* does not exist, refer to [Creating Cross Connections \(page 32\)](#) for more information.
2. Select **Enable Scrambling** to begin the scrambling process.

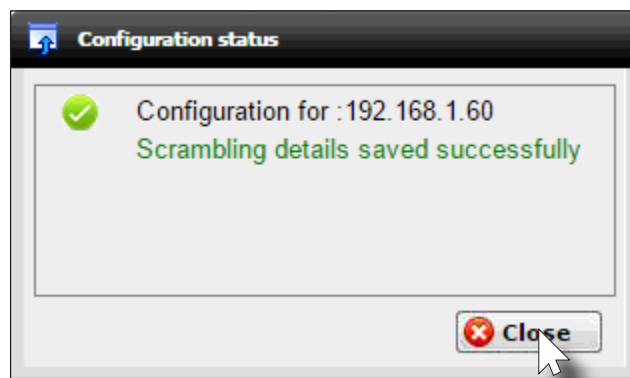
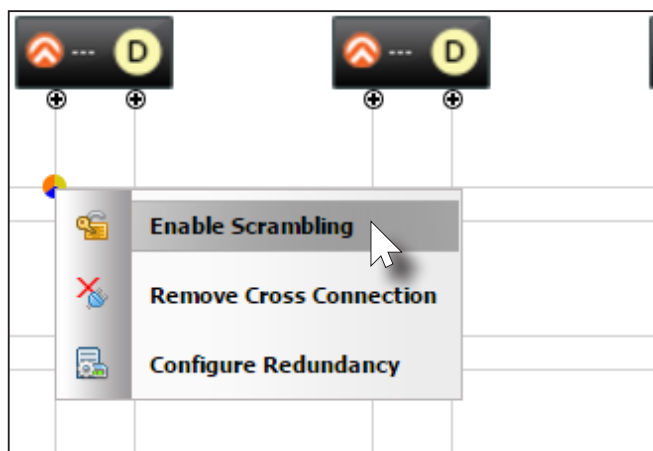

3. AMS will display a prompt message to confirm the operation. Click the **Close** button to dismiss the message box.

## Configuring Redundant Streams

OmniStream decoders have the ability to identify damaged or missing streams and will recover the image almost instantaneously. The decoder can access the same stream from two separate multicast addresses and switch between them, when necessary.

1. Right-click on the desired *cross connection*.
2. Select **Configure Redundancy**.

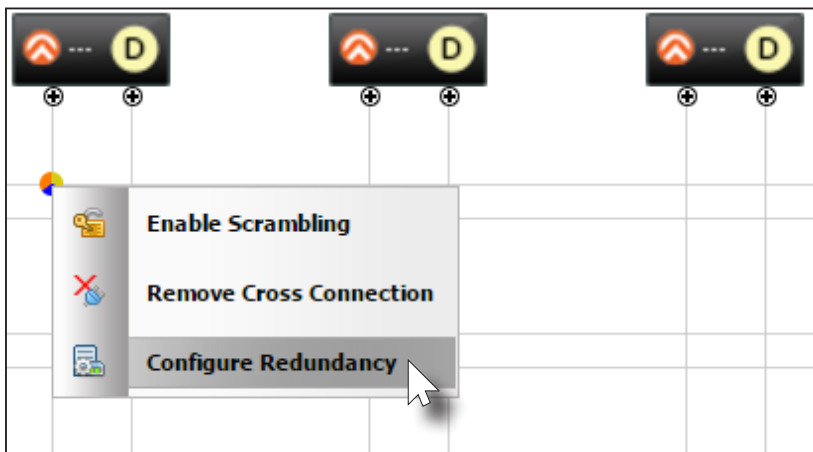

3. The **Configure Redundancy** dialog will be displayed.

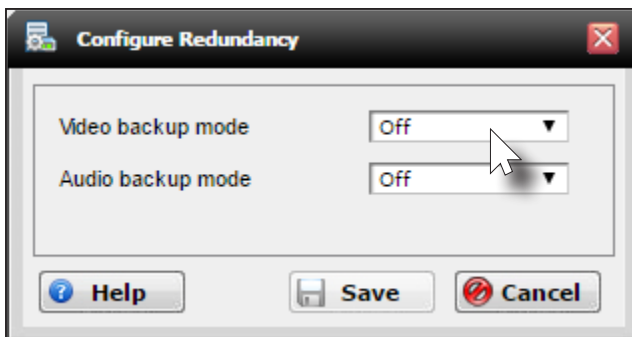

4. Select the backup mode for both video and audio from the **Video backup mode** and **Audio backup mode** drop-down lists.

Mode	Description
Off	Backup source is disabled; join request not sent.
Join Active	The decoder sends a join request only when the decoder decides to switch between sources. Switch time will not exceed 5 seconds.
Join Always	The decoder always joins to the backup source. Switch time will not exceed 0.5 seconds.

5. Click the **Save** button to save the changes.

# The AMS Interface

## System Information tab

The **System Info** tab provides general information about the encoder. The decoder has an identical interface. None of the fields under the **System Info** tab can be edited.

System Information	
<b>Input</b>	
<b>Encoding</b>	
<b>Serial</b>	
<b>Session</b>	
<b>Logo</b>	
<b>Alarms</b>	
<b>Network</b>	
<b>Users</b>	
<b>License</b>	
<b>Demo</b>	

System Information	
<b>Firmware Version</b>	1.0.0
<b>Model</b>	at-omni-112
<b>Description</b>	<input type="text"/>
<b>Location</b>	<input type="text"/>
<b>Date/Time</b>	01-20-1970 00:12:35
<b>Uptime</b>	0 day 1 hour 36 minutes
<b>Temperature</b>	41.00°C 105.8°F
<b>Hostname</b>	<input type="text" value="at-omni-112-00332"/>
<b>NTP Server</b>	<input type="text"/>
<b>SET DATE/TIME</b>	<input type="button" value="Set Date/Time"/>
<b>Buttons</b>	<input checked="" type="checkbox"/>
<b>LEDs</b>	<input checked="" type="checkbox"/>
<b>FACTORY RESET</b>	<input type="button" value="Factory Reset"/> <input type="checkbox"/> Reset User <input type="checkbox"/> Reset Network <input type="checkbox"/> Reset Defaults
<b>REBOOT</b>	<input type="button" value="Reboot"/>
<b>DEBUG</b>	<input type="button" value="Debug"/>
<b>IDENTIFY</b>	<input type="button" value="Identify"/>

### Firmware Version

Displays the current version of firmware.

### Model

The model of the unit.

Model	Description
AT-OMNI-111	Single-channel encoder
AT-OMNI-112	Dual-channel encoder

### Description

Enter a description for the encoder in this field. This field is optional.

### Location

Enter the text, describing the location of the encoder, in this field. This field is optional.

### Date / Time

The current date and time, measured using Coordinated Universal Time (UTC). UTC does not observe Daylight Savings Time (DST).

### Uptime

Time elapsed since the last reboot operation.

### Temperature

The current internal temperature of the unit, in degrees Celsius.

### Host Name

Enter the host name in this field. By default, the host name uses the product SKU and the last 5 digits of the serial number.

### NTP Server

Enter the NTP server in this field. This field is optional.

### SET DATE/TIME

Click this button to display **Set Date/Time** dialog box.

### FACTORY RESET

Click the **Factory Reset** button to reset the encoder. If no options are checked, then the unit is reset to factory-default settings. User and network information are preserved.

Option	Description
Reset User	Resets the encoder to factory-default settings and resets custom user information.
Reset Network	Resets the encoder to factory-default settings and resets network information.
Reset Defaults	Resets the encoder to factory-default settings. In addition, static multicast addresses are configured. This option can be used to configure a single encoder to transmit to any number of decoders without using the Virtual Matrix within AMS.   <b>NOTE:</b> This will not work for multiple encoders on the same network.

### REBOOT

Click the **Reboot** button to perform a soft reboot of the encoder.

### DEBUG

The **Debug** button places the encoder in *debug* mode.



**WARNING:** The **Debug** button is specifically designed for providing system-level troubleshooting information. Do not use this feature unless directed by an experience field technician or an Atlona Technical Support Engineer.

### IDENTIFY

Click the **Identify** button to identify the physical unit on a network. When this button is clicked, all the LED indicators on the front panel will flash for approximately 10 seconds.

## Input tab

The **Input** tab provides signal information for each channel (input). If using the single-channel encoder, only a single (input) channel will be displayed.

System Information	
Input	
Encoding	
Serial	
Session	
Logo	
Alarms	
Network	
Users	
License	
Demo	

Input 1	
Name	hdmi_input1
Cable Present	true
EDID	Default ▼
HDCP	
Encrypted	false
HDCP compliance	<input type="checkbox"/>
Video	
Audio	

Input 2	
Name	hdmi_input2
Cable Present	false
EDID	Default ▼
HDCP	
Encrypted	false
HDCP compliance	<input type="checkbox"/>
Video	
Audio	

Video Generator 1	
Name	video_generator1
Color Depth	8 ▼
Colorspace	YUV ▼

### Name

The name used by AMS to identify the HDMI input.

### Cable Present

Indicates whether or not a connection is detected.

This value is true if a signal is detected. If set to false, then check the cable connection and make sure that the source is powered. Damaged cables may also indicate a false state.

### EDID

Selects the desired EDID.

EDID	Description
Default	Default OmniStream EDID
ATL 1080P 2CH	1920x1080p60 with two-channel PCM audio
ATL 1080P DD	1920x1080p60 with Dolby Digital audio
ATL 1080P DVI	1920x1080p60 with video formatted as DVI
ATL 1080P MCH	1920x1080p60 with multichannel PCM audio
ATL 1280x800 RGB DVI PCWXGADVI	1280x800p60 with video formatted as DVI
ATL 1280x800 RGB PCWXGA2CH	1280x800p60 PC format with two-channel PCM audio
ATL 1280x800 RGB TVWXGA2CH	1280x800p60 TV format with two-channel PCM audio
ATL 2160P 2CH	3840x2160p30 with two-channel PCM audio
ATL 2160P MCH	3840x2160p30 with multichannel PCM audio



EDID	Description
ATL 720P DD	1280x720p60 with Dolby Digital audio
ATL 720P 2CH	1280x720p60 with two-channel audio

### Encrypted

Indicates if the content is HDCP-encrypted or not. If true, then HDCP content is being passed in to the decoder.

### HDCP compliance

Check this box to enable HDCP compliance. When checked, this decoder reports to the source that the decoder is an HDCP-compliant sink device. Otherwise, sink is reported as “non-compliant”.



**NOTE:** Disabling **HDCP compliance** *does not* decrypt HDCP content.

### Color Depth

The color depth of the input signal.

### Subsampling

The sampling frequency for the input video signal.

### Color Space

The color space of the input signal.

### Resolution

The video resolution of the input video signal.

### Frame Rate

The frame rate of the input video signal.

### Bit Depth

The bit depth of the input audio signal.

### Channel Count

The number of audio channels contained in the input audio signal.

### Format

The audio format of the input signal. If the input audio signal is compressed, such as Dolby Digital or DTS formats, this field will display unknown.

### Frequency

The frequency, measured in kilohertz, of the input audio signal.

The **Video Generator** block contains the following information. This signal can be used to test the video capability of the network. Dual-channel encoders will have two video generators. Single-channel encoders will have one video generator.

Video Generator 1	
<b>Name</b>	video_generator1
<b>Color Depth</b>	8 ▼
<b>Colorspace</b>	YUV ▼
<b>Framerate</b>	60
<b>Subsampling</b>	444 ▼
<b>Resolution Width</b>	1920
<b>Resolution Height</b>	1080

### Name

The internal name of the video generator. This field is read-only and cannot be changed.

### Color Depth

Click the drop-down list to select the color depth of the video signal.

### Colorspace

Click the drop-down list to select the color space of the video signal.

### Framerate

Enter the frame rate of the video in this field.

### Subsampling

Click the drop-down list to select the chroma subsampling value of the video signal.

### Resolution Width

Enter the horizontal resolution of the video signal in this field.

### Resolution Height

Enter the vertical resolution of the video signal in this field.

## Encoding tab

The **Encoder** tab provides the ability to select the input for each encoder channel. If using the single-channel encoder, only a single channel will be displayed.

<b>System Information</b>	
<b>Input</b>	
<b>Encoding</b>	
<b>Serial</b>	
<b>Session</b>	
<b>Logo</b>	
<b>Alarms</b>	
<b>Network</b>	
<b>Users</b>	
<b>License</b>	
<b>Demo</b>	

Encoder 1	
<b>Name</b>	vc2_encoder1
<b>Input</b>	hdmi_input1 ▼
<b>Bit Rate</b>	900
<b>Bit Depth</b>	8-bit ▼
<b>Subsampling</b>	4:2:2 ▼
<b>Force YUV</b>	<input checked="" type="checkbox"/>

Encoder 2	
<b>Name</b>	vc2_encoder2
<b>Input</b>	hdmi_input2 ▼
<b>Bit Rate</b>	900
<b>Bit Depth</b>	8-bit ▼
<b>Subsampling</b>	4:2:2 ▼
<b>Force YUV</b>	<input checked="" type="checkbox"/>

### Name

The name used by AMS to identify the encoder channel

### Input

Use the drop-down list to select the desired input.

Input	Description
hdmi_input1	HDMI IN 1
hdmi_input2	HDMI IN 2

### Bit Rate

The video bit rate. This value can be changed, if required. Note that specifying lower bit rates will reduce video quality. This value is in megabits-per-second (Mbps).

### Bit Depth

Click this drop-down list to select the desired maximum bit depth. Any input with a higher bit depth will be reduced to the selected value.

### Subsampling

Click this drop-down list to select the desired maximum chroma subsampling value. Any input with a higher chroma subsampling will have their chroma scaled to the configured value using a very high quality chroma scaler to preserve quality.

### Force YUV

Click this checkbox to force the output of the decoder to output YUV regardless of whether the input to the encoder is RGB or YUV. In order for the chroma scaling to work on RGB inputs, this option must be selected.

## Serial tab

The **Serial** tab provides serial port configuration when using control signals.

System Information	
Input	
Encoding	
Serial	
Session	
Logo	
Alarms	
Network	
Users	
License	
Demo	

Serial Port Configuration	
Name	serial_port1
Baudrate	9600 ▼
Data	8 ▼
Parity	none ▼
Stop	1 ▼
Flow Control	none ▼

Serial Port Configuration	
Name	serial_port2
Baudrate	9600 ▼
Data	8 ▼
Parity	none ▼
Stop	1 ▼
Flow Control	none ▼

Serial configuration	
Name	serial_use1
Port	Not Used ▼
Mode	cli ▼

Serial configuration	
Name	serial_use2

### Name

The name used by AMS to identify the serial port.

### Baudrate

Click this drop-down list to select the desired baud rate.

### Data

Click this drop-down list to select the number of data bits.

### Parity

Click this drop-down list to select the parity bit.

### Stop

Click this drop-down list to select the stop bit.

### Flow

Click this drop-down list to select the type of flow control.

Serial configuration	
<b>Name</b>	serial_use1
<b>Port</b>	Not Used ▼
<b>Mode</b>	cli ▼

### Name

The name used by AMS to identify the serial port.

### Port

Click this drop-down list to select the port.

### Mode

Click this drop-down list to select the desired control mode.

The **Command** blocks are used to enter the command string for the desired operation.

Command: Display Off	
Interpret on	decoder ▼
ASCII	<input type="text"/>
HEX	<input type="text"/>
Command: Display On	
Interpret on	decoder ▼
ASCII	<input type="text"/>
HEX	<input type="text"/>
Command: Volume Down	
Interpret on	decoder ▼
ASCII	<input type="text"/>
HEX	<input type="text"/>
Command: Volume Up	
Interpret on	decoder ▼
ASCII	<input type="text"/>
HEX	<input type="text"/>

### Interpret on

Click this drop-down list to select where the command will be interpreted.

Interpret on	Description
decoder	Commands are interpreted at the decoder.
encoder	Commands are interpreted at the encoder.

### ASCII

Enter the ASCII representation of the command string in this field.

### HEX

Enter the hexadecimal representation of the command string in this field.



**NOTE:** When entering the command string, it is not required to enter the string under both the ASCII and HEX fields. The encoder requires that one field be completed.

## Session tab

The **Session** tab provides the ability to configure all session parameters. Up to four sessions are supported on dual-channel encoders. Single-channel encoders are limited to a maximum of two sessions.

System Information	Session 1	Session 2	Session 3	Session 4
Input				
Encoding				
Serial				
Session				
Logo				
Alarms				
Network				
Users				
License				
Demo				

Session 1	
Name	session1
Interface	eth1
SAP	
Enable	<input type="checkbox"/>
Scrambling	
Enable	<input checked="" type="checkbox"/>
Key	12345678
Video	
Encoder	vc2_encoder1
Enable	<input checked="" type="checkbox"/>
Destination IP Address	226.0.0.1
Destination UDP Port	1000
TTL	255
DSCP	Best effort
FEC Enable	<input checked="" type="checkbox"/>
FEC rows	15
FEC Columns	15
Audio	
Source	hdmi_input1

### Name

The name used by AMS to identify the session.

### Interface

Click this drop-down list to select the desired interface.

Interface	Description
eth1	Ethernet 1
eth2	Ethernet 2

### Enable

Check this box to enable the Session Announcement Protocol.

### Enable (Scrambling)

Check this box to enable scrambling. Scrambling can also be enabled/disabled using the **Virtual Matrix**. Refer to [Scrambling \(page 36\)](#) for more information.

### Key

Enter the scrambling key in this field. The scrambling key must be ASCII and must contain a minimum of eight characters. Special characters and spaces are not permitted.

Video	
Encoder	vc2_encoder1 ▼
Enable	<input checked="" type="checkbox"/>
Destination IP Address	226.0.0.1
Destination UDP Port	1000
TTL	255
DSCP	Best effort ▼
FEC Enable	<input checked="" type="checkbox"/>
FEC rows	15
FEC Columns	15

### Encoder (Video)

Select the desired encoder stream from this drop-down list. Refer to the **Encoding** tab for basic configuration of the encoder stream.

### Enable (Video)

Click the **Enable** checkbox to enable the video stream. To disable the video stream, uncheck this box. By default, video streaming is *enabled*. Disabling the video stream can be used to “mask” the video on several decoder endpoints.

### Destination IP Address

Enter the IP address that will be used by the decoder endpoint. By default, AMS will automatically populate multicast IP addresses for the encoder.

### Destination UDP Port

Enter the UDP port in the **Destination UDP Port** field.

### TTL

Set the TTL (Time-To-Live) duration, from 1 to 255 seconds, in this field. The default value is 255 seconds.

### DSCP

Select the Differentiated Services Code Point (DSCP) type from the **DSCP** drop-down list. This value will be used to determine the Quality of Service (QoS) on a network. The available values are: Best Effort, Low, Normal, High, and Highest. The Best Effort setting will provide normal priority for data packets, while a setting of Highest will prioritize data packets as critical. However, it should be noted that a higher priority setting may also result in high data packet loss, depending upon network traffic.

### FEC Enable

Check this box to enable Forward Error Correction (FEC). This feature can be used when transporting streams over a network that is suspected to be unreliable, due to noise or other factors. By default, this checkbox is checked. Refer to [FEC Details \(page 57\)](#) for more information.

### FEC rows

Specify the number of FEC rows in this field. Refer to [FEC Details \(page 57\)](#) for more information.

### FEC Columns

Specify the number of FEC columns in this field. Refer to [FEC Details \(page 57\)](#) for more information.

**FEC rows** and **FEC Columns** only applies when FEC is *enabled*. When enabled, the number of *rows* and *columns* will be used for each data packet, causing an FEC packet to be added to each row and column, providing burst error correction. For example, a five-row, five-column FEC structure would add a five-row and five-column FEC packet to every 25 data packets. This allows error correction of up to five packets in length, in addition to replacing missing data packets. Refer to [FEC Details \(page 57\)](#) for more information.

Audio	
Source	hdmi_input1 ▼
Enable	<input checked="" type="checkbox"/>
Destination IP Address	226.0.0.8
Destination UDP Port	1100
TTL	255
DSCP	Best effort ▼
FEC Enable	<input type="checkbox"/>
FEC rows	4
FEC Columns	4

### Source

Select the desired HDMI input from the **Source** drop-down list.

### Enable (Audio)

Click the **Enabled** checkbox to enable the audio stream. To disable the audio stream, do not check this box. By default, audio streaming is *disabled*.

### Destination IP Address

Enter the endpoint IP address in the **Destination IP Address** field.

### Destination UDP Port

Enter the UDP port in the **Destination UDP Port** field.

### TTL

Set the Time-To-Live (TTL) duration, from 1 to 255 seconds, in this field. The default value is 255 seconds.

### DSCP

Select the Differentiated Services Code Point (DSCP) type from the **DSCP** drop-down list. This value will be used to determine the Quality of Service (QoS) on a network. The available values are: Best Effort, Low, Normal, High, and Highest. The Best Effort setting will provide normal priority for data packets, while a setting of Highest will prioritize data packets as critical. However, it should be noted that a higher priority setting may also result in high data packet loss, depending upon network traffic.

### FEC Enable

Check this box to enable Forward Error Correction (FEC). This feature can be used when transporting streams over a network that is suspected to be unreliable, due to noise or other factors. By default, this checkbox is checked. Refer to [FEC Details \(page 57\)](#) for more information.

### FEC rows

Specify the number of FEC rows in this field. Refer to [FEC Details \(page 57\)](#) for more information.

### FEC Columns

Specify the number of FEC columns in this field. Refer to [FEC Details \(page 57\)](#) for more information.



AUX	
Source	serial_port1 ▼
Enable	<input checked="" type="checkbox"/>
Destination IP Address	226.0.0.9
Destination UDP Port	1200
TTL	255
DSCP	Best effort ▼
Bidirectional	<input type="checkbox"/>
Listen Port	1204

### Source

Click this drop-down list to select the method of how commands are transmitted using the AUX data stream.

Source	Description
Commands	Commands are sent using CEC (over HDMI)
serial_port1	Commands are transmitted using Serial Port 1
serial_port2	Commands are transmitted using Serial Port 2

### Enable

Click the **Enable** checkbox to enable the auxiliary stream. To prevent data from being sent over this channel, uncheck this box. By default, this feature is *disabled*.

### Destination IP Address

Enter the endpoint IP address in the **Destination IP Address** field.

### Destination UDP Port

Enter the UDP port in the **Destination UDP Port** field.

### TTL

Set the TTL (Time-To-Live) duration, from 1 to 255 seconds, in the **TTL** field. The default value is 255 seconds.

### DSCP

Select the Differentiated Services Code Point (DSCP) type from the **DSCP** drop-down list. This value will be used to determine the Quality of Service (QoS) on a network. The available values are: Best Effort, Low, Normal, High, and Highest. The Best Effort setting will provide normal priority for data packets, while a setting of Highest will prioritize data packets as critical. However, it should be noted that a higher priority setting may also result in high data packet loss, depending upon network traffic.

### Bidirectional

Click this checkbox enable bidirectional serial control. This option only works when the data stream is in unicast mode.

### Listen Port

Enter the listening port for the data channel in this field, when using bidirectional serial control.

## Logo tab

The **Logo** tab provides the ability to upload a custom logo. This logo will be displayed when no video signal is detected. When using dual-channel encoders, separate logos can be uploaded: one for each channel.

System Information	
Input	
Encoding	
Serial	
Session	
Logo	
Alarms	
Network	
Users	
License	
Demo	

New Logo	
<input type="button" value="Upload Logo"/>	
logo_insertion1	
<b>Target</b>	vc2_encoder1
<b>Enable</b>	<input type="checkbox"/>
<b>Logo</b>	Not Used ▼
<b>Aspect ratio</b>	stretch ▼
Location	
<b>Horizontal</b>	<input type="text" value="0"/>
<b>Vertical</b>	<input type="text" value="0"/>
Size	
<b>Height</b>	<input type="text" value="0"/>
<b>Width</b>	<input type="text" value="0"/>
logo_insertion2	
<b>Target</b>	vc2_encoder2
<b>Enable</b>	<input type="checkbox"/>
<b>Logo</b>	Not Used ▼
<b>Aspect ratio</b>	stretch ▼
Location	
<b>Horizontal</b>	<input type="text" value="0"/>
<b>Vertical</b>	<input type="text" value="0"/>

### Upload Logo

Click this button to upload the logo file. Files must be in .png format and must not exceed 5 MB (5120000 bytes) in size. When an image file is uploaded, it will appear in the **Logo** drop-down list.

### Target

The name used by AMS to identify the encoder.

### Enable

Click this checkbox to display the logo. If this box is unchecked, then the logo will not be displayed.

### Logo

Click this drop-down list to select the desired logo.

### Aspect Ratio

Click this drop-down list to select the type of aspect ratio to be applied to the logo.

### Horizontal

Enter the horizontal position of the logo on the screen.

### Vertical

Enter the vertical position of the logo on the screen.

### Height

Enter the horizontal resolution of the logo, in pixels.

### Width

Enter the vertical resolution of the logo, in pixels.



**NOTE:** Maximum logo resolution (both height and width) is 1/4 of the video resolution.

## Alarms tab

The **Alarms** tab provides a list of all alarms and warnings that have been detected. If no alarms or warnings are active, then the page will display No alarms. A list of alarms, warnings, and their descriptions are in the tables, below.

System Information	
Input	
Encoding	
Serial	
Session	
Logo	
Alarms	
Network	
Users	
License	
Demo	

DHCP timeout on eth1	
Timestamp	07-01-1970 01:02:42
Description	No DHCP response on eth1
Active	false

## Platform

Message	Description
Over temperature	Unit temperature is exceeding operational specifications.

## Video Interface

Message	Description
HDMI1 video absent	Hot plug detected but no TMDS
HDMI2 video absent	Hot plug detected but no TMDS
Unsupported Resolution	Resolution is not supported
Unsupported Frame rate	Frame rate is not supported
Auto switched to HDMI 1	Unit has been automatically switched to HDMI 1
Auto switched to HDMI 2	Unit has been automatically switched to HDMI 2

## Audio I/F

Message	Description
HDMI1 no audio	No audio signal is present
HDMI2 no audio	No audio signal is present
No volume control unit is on mute	Displayed when volume is increased while unit is in Mute mode

## IP Protocol

Message	Description
IP address not supported	Invalid IP address has been assigned

## Network tab

The **Network** tab provides the ability to enable or disable DHCP mode for each video channel. When DHCP mode is disabled, the IP address, subnet mask, and gateway must be provided. If using the dual-channel version, then the information on both Channel 1 and Channel 2 are provided. This screen is identical to the **Network** tab for the decoder.

System Information	
Input	
Encoding	
Serial	
Session	
Logo	
Alarms	
Network	
Users	
License	
Demo	

Network 1	
Name	eth1
Enabled	true
Carrier	false
Mode	<input checked="" type="radio"/> DHCP <input type="radio"/> Static
IP Address	192.168.11.76
Subnet	255.255.255.0
Gateway	192.168.11.1
Link Speed	10
MAC Address	B8:98:B0:01:87:A9

Network 2	
Name	eth2
Enabled	true
Carrier	true
Mode	<input type="radio"/> DHCP <input checked="" type="radio"/> Static
IP Address	192.168.11.254
Subnet	255.255.255.0
Gateway	192.168.11.1
Link Speed	1000
MAC Address	B8:98:B0:01:87:AA

### Name

The name / Ethernet cable ID, used by AMS, to identify the channel.

### Enabled

This field indicates that the video stream, for this channel, is active.

### Carrier

If this field is true, then an active link exists. Otherwise, this field is set to false.

### Mode

Click the radio button for the desired network mode. Select DHCP to let the DHCP server (if present) assign the encoder the IP settings. When **Static** mode is selected, the information for the **IP Address**, **Subnet**, and **Gateway** fields must be entered.

### IP Address

Displays the IP address used by the channel. This field can only be changed if **Static** mode is selected.

### Subnet

Displays the subnet mask for the channel. This field can only be changed if **Static** mode is selected.

### Gateway

Displays the gateway (router) address for the channel. This field can only be changed if **Static** mode is selected.

### Link Speed

Displays the port speed in Mbps.

### MAC Address

The MAC address of the channel.

## Users tab

The **Users** tab provides the ability to manage user access rights. Two access levels are available: admin and operator. Creating users requires Administrator access.

System Information	
Input	
Encoding	
Serial	
Session	
Logo	
Alarms	
Network	
Users	
License	
Demo	

User 1	
<b>Username</b>	<input type="text" value="operator"/>
<b>Role</b>	<input style="border-bottom: 1px solid black;" type="text" value="operator"/>
<b>New Password</b>	<input type="text" value="N/A"/>
<b>Repeat Password</b>	<input type="text" value="N/A"/>
<input type="button" value="Delete"/>	<input type="button" value="Save"/>

User 2	
<b>Username</b>	<input type="text" value="admin"/>
<b>Role</b>	<input style="border-bottom: 1px solid black;" type="text" value="administrator"/>
<b>New Password</b>	<input type="text" value="N/A"/>
<b>Repeat Password</b>	<input type="text" value="N/A"/>
<input type="button" value="Delete"/>	<input type="button" value="Save"/>

### Username

The name of the assigned user.

### Role

Select one of the following options from this drop-down list.

User	Description
Administrator	Ability to create, delete, and manage all users, in addition to “routing” operations within the Virtual Matrix.
Operator	Restricted to “routing” encoders to decoders within the Virtual Matrix.

### New Password

Enter the password for the username.

### Repeat Password

Verify the password by retyping the password in this field.

### Delete

Deletes the user.

### Save

Saves all changes to the user.

### Add User

Click this button to create a new user.

## License tab

The **License** tab is used to install licenses on OmniStream products. For OmniStream v1.0.0, all available licenses are pre-installed on units at the factory.

System Information							
Input	<b>4k</b>						
Encoding	Installed true						
Serial	Key 4K:5f66009d4842962cf6bef0eba011c9fd1e740d4677ab0a543149a3dd4881a95b08cd4d148d51f280b2ae8a6f172add771c3b0ee464015ee24bc54b8c						
Session	Request 4K:b898b00187a9						
Logo	<b>fec</b>						
Alarms	Installed true						
Network	Key FEC:4cd105d45fdb4775be1837800935035b89e83b713be57330ec2af9012a326560748777fd8ad690cfa4c1f127e2877efb1a05ae4ac11cc8b03f4cd8ca						
Users	Request FEC:b898b00187a9						
License	<b>scrambling</b>						
Demo	Installed true						
	Key SCRAMBLING:02a08c32e53afb95cecbd871495d429dfe1befc5190b20ba974707c2206d637631e202e4e11a626251524504434f7c4bcfb3003da916a2ad						
	Request SCRAMBLING:b898b00187a9						
	<b>Keys can be obtained through Atona by using one of the requests.</b>						
	<table border="1" style="width: 100%; border-collapse: collapse;"> <tr> <td colspan="2" style="background-color: #34495e; color: white; font-weight: bold;">Install License</td> </tr> <tr> <td style="width: 70%;">License Key</td> <td><input style="width: 90%;" type="text"/></td> </tr> <tr> <td colspan="2" style="text-align: right;"> <input type="button" value="Install License"/> </td> </tr> </table>	Install License		License Key	<input style="width: 90%;" type="text"/>	<input type="button" value="Install License"/>	
Install License							
License Key	<input style="width: 90%;" type="text"/>						
<input type="button" value="Install License"/>							

### License Key

Enter the license number in this field.

### Install License

Click this button to install the license, once the license key has been entered.

## Demo tab

The **Demo** tab is used to demonstrate the benefits of using Forward Error Correction. IP Packet Drop provides the option to force the encoder to simulate network traffic by dropping random packets on the Ethernet interface, allowing the decoder to use FEC to recover the lost packets. FEC should be enabled when running this test. Enabling or disabling FEC can be found under the **Session** tab (page 46). Refer to **FEC Details** (page 57) for more information.

System Information													
Input													
Encoding													
Serial													
Session													
Logo													
Alarms													
Network													
Users													
License													
Demo	<table border="1"> <thead> <tr> <th colspan="2">Demo 1</th> </tr> </thead> <tbody> <tr> <td>Network</td> <td>eth1</td> </tr> <tr> <td>IP Packet Drop</td> <td>Moderate Errors ▼</td> </tr> </tbody> </table> <table border="1"> <thead> <tr> <th colspan="2">Demo 2</th> </tr> </thead> <tbody> <tr> <td>Network</td> <td>eth2</td> </tr> <tr> <td>IP Packet Drop</td> <td>Moderate Errors ▼</td> </tr> </tbody> </table>	Demo 1		Network	eth1	IP Packet Drop	Moderate Errors ▼	Demo 2		Network	eth2	IP Packet Drop	Moderate Errors ▼
Demo 1													
Network	eth1												
IP Packet Drop	Moderate Errors ▼												
Demo 2													
Network	eth2												
IP Packet Drop	Moderate Errors ▼												

### Network

The name of the Ethernet cable ID, used by AMS.

### IP Packet Drop

Click this drop-down list to select the severity of the packet drop.

Option	Description	Recommendations
No Errors	Simulates a network with no packet drops.	N/A
Moderate Errors	Simulates typical network traffic with moderate packet drops.	8x8 matrix.
Heavy Errors	Simulates heavy network traffic with frequent packet drops.	N/A - This setting is beyond the capabilities of FEC to recover.



# Appendix

## FEC Details

### Matrix Size, Overhead, and Latency

- FEC can only work if a single packet from each row/column are missing. Multiple packets missing from each row/column will cause FEC to fail.
- Due to the above, a smaller matrix is more robust, as there is a better chance of errors not occurring in the same row/column.
- FEC has a bitrate overhead that is inversely proportional to the matrix size: the bigger the matrix, the less bitrate overhead is generated.
- FEC has a latency overhead that is directly proportional to the matrix size: the bigger the matrix, the more latency is introduced.
  - » As of v1.0.0, OmniStream does not explicitly synchronize audio and video. Therefore, FEC configuration can have a noticeable impact on lip sync. The tables below should be used to keep the audio/video lip sync as tight as possible.
- FEC latency overhead is also inversely proportional to bitrate: the higher the bitrate, the less FEC latency is introduced.
  - » For applications where lip sync is very critical, using a higher audio sampling rate, and thus a higher audio bitrate, can result in more accurate lip sync.

### FEC and Video Bitrate

- The bitrate configured on the video encoder includes FEC overhead and will automatically adjust itself depending on the bitrate needed for FEC.
- FEC overhead can be calculated using the following formulas:

$$Video\ rate = \frac{Configured\ bit\ rate}{1 + \left( \frac{Rows + Columns}{Rows \times Columns} \right)} \qquad FEC\ rate = Configured\ bit\ rate - Video\ rate$$

- The following table provides a few examples of how this works.

FEC / matrix usage	Configured bit rate	Used for video	Used for FEC
FEC disabled	900 Mbps	900 Mbps	0 Mbps
FEC enabled, 4x4	900 Mbps	600 Mbps	300 Mbps
FEC enabled, 10x10	900 Mbps	750 Mbps	150 Mbps
FEC enabled, 20x20	900 Mbps	818 Mbps	82 Mbps
FEC enabled, 4x4	450 Mbps	300 Mbps	150 Mbps
FEC enabled, 10x10	450 Mbps	375 Mbps	75 Mbps
FEC enabled, 20x20	450 Mbps	409 Mbps	41 Mbps

### FEC, Latency, and Lip Sync

- In order for FEC to work, the matrix must be filled in order to calculate the FEC packets. This introduces some additional latency. Due to high bitrates, this is not noticeable for video, but can be very significant for audio. Therefore, Atlona recommends either leaving FEC disabled for audio or using a very small matrix.
- Latency calculations are complex. The tables below provide some common working benchmarks. In order to minimize lip sync issues, try to match the additional latencies for video and audio as closely as possible.
  - » Video - additional video latency for enabling FEC using various matrix sizes.

Configured bit rate	4x4	10x10	20x20
900 Mbps	0.64 ms	3.20 ms	11.74 ms
450 Mbps	1.28 ms	6.40 ms	23.47 ms

- » Audio - additional audio latency for enabling FEC using various matrix sizes.

Format	1x4	2x4	4x4	10x10
2 channel PCM, 44.1 kHz	34.01 ms	68.03 ms	136.10 ms	850.30 ms
2 channel PCM, 48 kHz	31.25 ms	62.50 ms	125.00 ms	781.30 ms
2 channel PCM, 96 kHz	15.63 ms	31.25 ms	62.50 ms	390.60 ms
2 channel PCM, 192 kHz	7.81 ms	15.63 ms	31.25 ms	195.30 ms

- It is recommended to keep lip sync within  $\pm 1$  frame of video to prevent any noticeable syncing issues.
- Examples of good choices to minimize lip sync issues are:
  - » Video configured for 450 Mbps, FEC 10x10; Audio is 2 channel PCM, 192 kHz, FEC 1x4: 6.40 ms – 7.81 ms = -1.41 ms
  - » Video configured for 900 Mbps, FEC 10x10; Audio is 2 channel PCM, 48 kHz, FEC disabled: 6.40 ms – 0 ms = 6.40 ms

## Mounting Instructions

OmniStream encoders includes two mounting brackets and four mounting screws, which can be used to attach the unit to any flat surface.

1. Using a small Phillips screwdriver, remove the two screws from the left side of the enclosure.

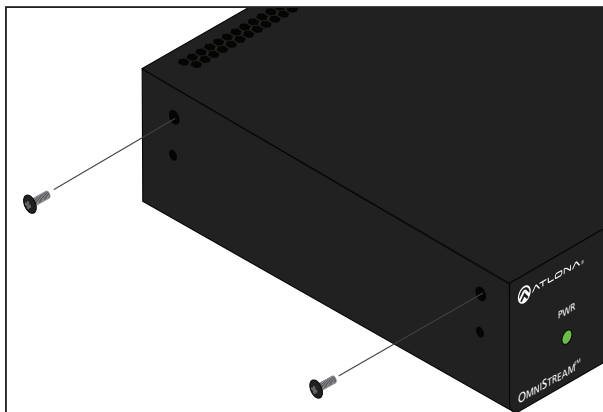

2. Position one of the rack ears, as shown below, aligning the holes on the side of the enclosure with one set of holes on the rack ear.
3. Use the enclosure screws to secure the rack ear to the enclosure.

Included screws

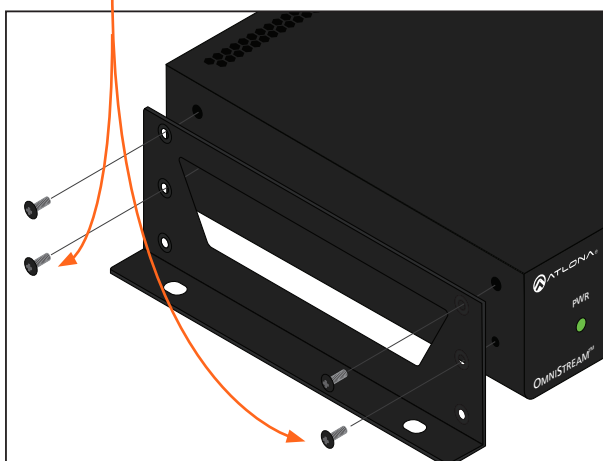

4. To provide added stability to the rack ear, use two of the included screws and attach them to the two holes, directly below the enclosure screws, as shown above.
5. Repeat steps 1 through 4 to attach the second rack ear to the opposite side of the unit.

6. Mount the unit using the oval-shaped holes, on each rack ear. If using a drywall surface, a #6 drywall screw is recommended.

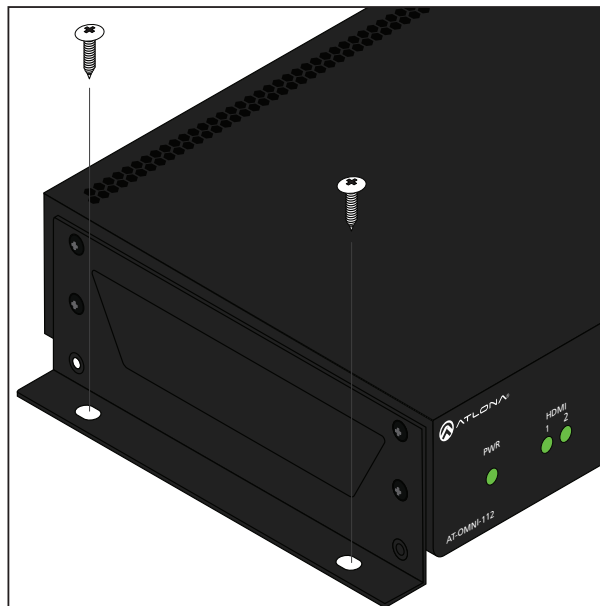

**NOTE:** Rack ears can also be inverted to mount the unit under a table or other flat surface.

## Rack Tray for OmniStream

OmniStream encoders can also be mounted in the OmniStream rack tray (AT-OMNI-1XX-RACK-1RU). The rack tray is sold separately and provides easy mounting and organization of up to two OmniStream encoders/decoders in a convenient 1U rack tray. The OmniStream rack tray can be purchased directly from Atlona.

1. Position the OmniStream products, as shown in the illustration below.
2. Using the included screws, secure each unit to the rack with a Philips screwdriver.



**NOTE:** OmniStream units can be mounted forward-facing or back-facing, depending upon your requirements.

3. Install the entire assembly into an empty 1U slot in the rack.

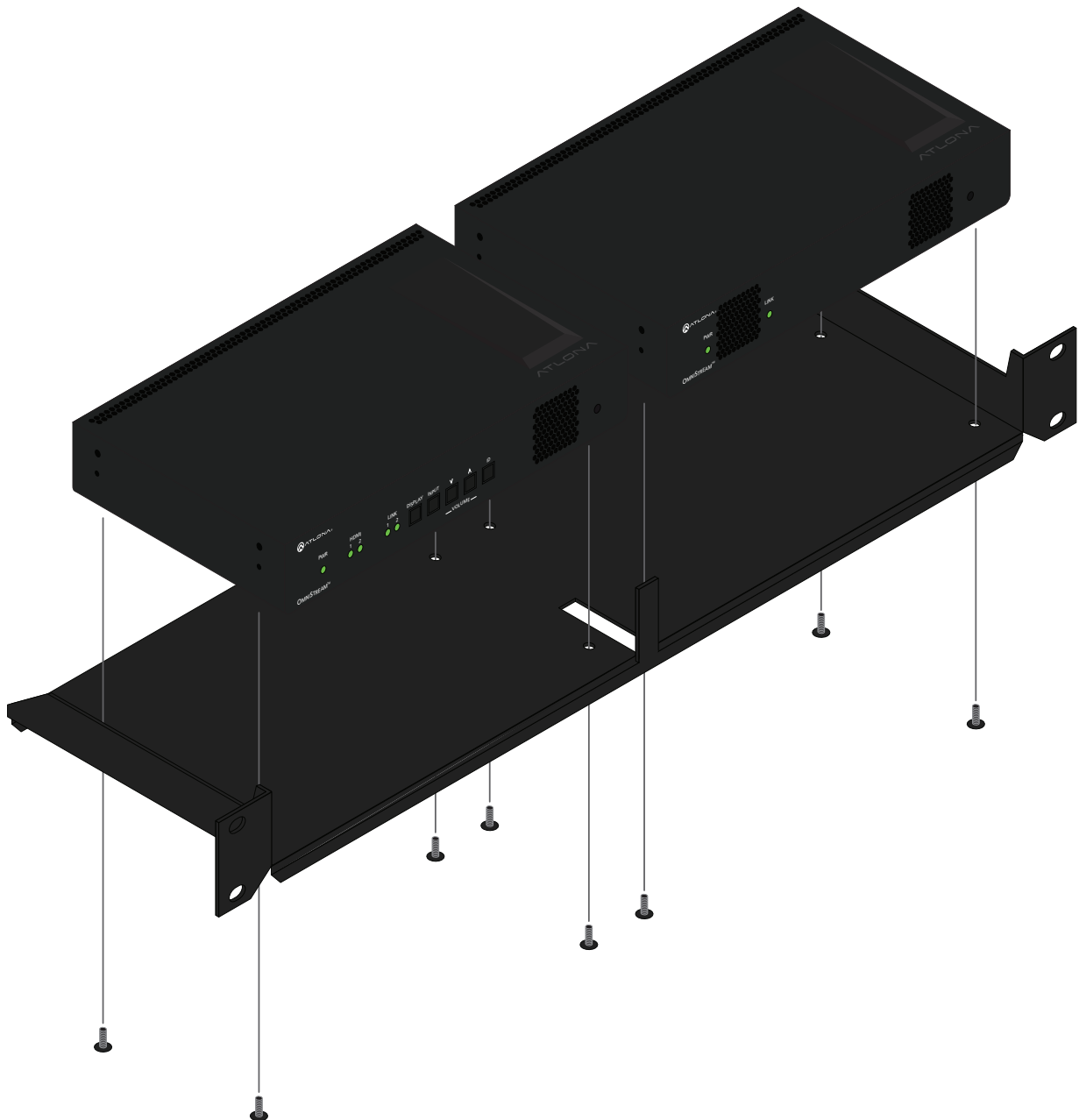

## Specifications

Video	
HD/SD	4096x2160@24Hz, 3840x2160@24/25/30Hz (UHD), 1080p@23.98/24/25/29.97/30/50/59.94/60Hz, 1080i@25/29.97/30Hz, 720p@30/50/59.94/60Hz
VESA*	1920x1200, 1680x1050, 1600x1200, 1600x900, 1440x900, 1400x1050, 1366x768, 1360x768, 1280x1024, 1280x800, 1280x768, 1152x768, 1024x768
Color Space	YUV, RGB
Codec	VC-2
Chroma Subsampling	4:4:4, 4:2:2
Color Depth	8-bit, 10-bit, 12-bit
Scaling	Yes

Audio	
HDMI	LPCM 2.0, LPCM 5.1, LPCM 7.1, Dolby® Digital, Dolby Digital Plus, Dolby TrueHD, Dolby Atmos®, DTS® 5.1, DTS-HD Master Audio™
Analog	2-channel balanced input / output
Sample Rate	32 kHz, 44.1 kHz, 48 kHz, 88.2 kHz, 96 kHz, 176.4 kHz, 192 kHz
Bit Rate	24-bit (max.)

Distance	Feet	Meters
Per hop of Ethernet cable	330	100

Signal	
CEC	Yes; display, volume, power, input
HDCP	1.4 switchable, hardware capable 2.2
Scrambling	AES 128

IP	
Protocol	RTP
Ethernet Speed	10/100/1000 Mbps
Addressing	DHCP, static
QoS tagging	RFC 2475
FEC	SMPTE 2022-5:2013; Columns: 1 to 20; Rows: 4 to 20

RS-232	
Baud Rate	2400 to 115200 bp/s
Connector	Molex, 3-pin x 2

Temperature	Fahrenheit	Celsius
Operating	32 to 122	0 to 50
Storage	-4 to 140	-20 to 60
Humidity (RH)	20% to 90% (non-condensing)	

Power	
Consumption	~13 W (w/o analog audio), TBD (w/ analog audio)
Supply (optional)	Input: 85 V ~ 264 V AC 50/60 Hz Output: 48 V DC, 0.83 A
SKU	AT-PS-48083-C

Dimensions	Millimeters	Inches
H x W x D	34 x 208 x 112	1.34 x 8.19 x 4.41

Weight	Kilograms	Pounds
Single channel	TBD	TBD
Dual-channel	0.7	1.54

Certification	
Power Supply	CE, FCC, cULus, RoHS, RCM
Product	CE, FCC, RoHS

\* All VESA resolutions are 60p.

